

BX Heavy Duty Series

IE3



Three-phase asynchronous motors



PRODUCTS &
SOLUTIONS

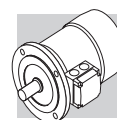

Chapter	Description	Page	Chapter	Description	Page
1	Symbols and units of measurement	2	8	DC brake motors type FD	29
2	Introduction	3	8.1	Degree of protection	30
3	General characteristics	5	8.2	FD brake power supply	30
3.1	Production range	5	8.3	FD brake technical specifications	32
3.2	Standards	5	8.4	FD brake connections	33
3.3	Directives 2006/95/EC (LVD) and 2004/108/EC (EMC)	6	9	AC brake motors type FA	34
3.4	EU Directive 2012/19/EU Information on disposal	6	9.1	Degree of protection	34
3.5	Tolerances	6	9.2	FA brake power supply FA	35
4...4.2	Motor designation	7	9.3	Technical specifications of FA brakes	35
4.3	Variants	10	9.4	FA brake connections	36
4.4	Options	10	10	Brake release systems	37
4.5	Brake-related options	11	10.1	Release lever orientation	38
4.6	Example of identification plate	11	10.2	Separate brake supply	38
5	Mechanical features	12	11	Options	39
5.1	Versions	12	11.1	Soft-start / stop	39
5.2	Degree of protection	13	11.2	Capacitive filter	39
5.3	Cooling	14	11.3	Thermal protective devices	39
5.4	Direction of rotation	15	11.4	Thermistors	40
5.5	Noise	15	11.5	Bimetallic thermostates	40
5.6	Vibrations and balancing	15	11.6	Plug connector	40
5.7	Terminal box	15	11.7	Control of brake operation	43
5.8	Cable entry	16	11.8	Additional cable entry for brakemotors	43
5.9	Bearings	16	11.9	Anti-condensation heaters	43
6	Electrical characteristics	17	11.10	Tropicalization	44
6.1	Voltage	17	11.11	Second shaft extension	44
6.2	Frequency	18	11.12	Rotor balancing	44
6.3	Ambient temperature	19	11.13	Ventilation	45
6.4	50 HZ normalized power	19	11.14	Rain canopy	47
6.5	Motors for USA and Canada	20	11.15	Textile canopy	47
6.6	Motors certified for India	21	11.16	Feedback units	47
6.7	China Compulsory Certification	22	11.17	Insulated Bearings	49
6.8	Motor certified for China (China Energy Label)	22	11.18	Vertical Mounting	49
6.9	Motors certified for Brazil	23	11.19	Surface protection	49
6.10	Motors certified for Australia	23	11.20	Painting	50
6.11	Insulation class	23	11.21	Certificates	51
6.12	Type of duty	24	12	Tables of motors correlation	51
6.13	Inverter-controlled motors	25	12.1	50 Hz Motors	51
6.14	Permissible starts per hour, Z	26	12.2	60 Hz Motors	53
7	Asynchronous brake motors	28	13	Motor rating charts BX	56
7.1	Operation	28	14	Motors dimensions BX	61
7.2	Most significant features	28	15	Motor rating charts BE	73
			16	Motors dimensions BE	75
			17	Motor rating charts BN	78
			18	Motors dimensions BN	88

Revisions

Refer to page 98 for the catalogue revision index. Visit www.bonfiglioli.com to search for catalogues with up-to-date revisions.

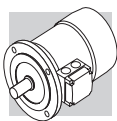

1 SYMBOLS AND UNITS OF MEASUREMENT

Symbols	Units of Measure	Description	Symbols	Units of Measure	Description
$\cos\varphi$	–	Power factor	n	[min ⁻¹]	Rated speed
η	–	Efficiency	P_B	[W]	Power drawn by the brake at 20°C
f_m	–	Power adjusting factor	P_n	[kW]	Motor rated power
I	–	Cyclic duration factor	P_r	[kW]	Required power
I_N	[A]	Rated current	t_1	[ms]	Brake response time with one-way rectifier
I_S	[A]	Locked rotor current	t_{1s}	[ms]	Brake response time with electronic-controlled rectifier
J_C	[Kgm ²]	Load moment of inertia	t_2	[ms]	Brake reaction time with a.c. disconnect
J_M	[Kgm ²]	Moment of inertia	t_{2c}	[ms]	Brake reaction time with a.c. and d.c. disconnect
K_c	–	Torque factor	t_a	[°C]	Ambient temperature
K_d	–	Load factor	t_f	[min]	Work time at constant load
K_J	–	Inertia factor	t_r	[min]	Rest time
M_A	[Nm]	Mean breakaway torque	W	[J]	Braking work between service interval
M_B	[Nm]	Brake torque	W_{max}	[J]	Maximum brake work for each braking
M_N	[Nm]	Rated torque	Z	[1/h]	Permissible starting frequency, loaded
M_L	[Nm]	Counter-torque during acceleration	Z_0	[1/h]	Max. permissible unloaded starting frequency (I = 50%)
M_S	[Nm]	Starting torque			

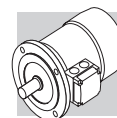

2 INTRODUCTION

Efficiency classes and test methods

Efficiency classes characterise the efficiency with which an electric motor converts electrical energy into mechanical energy. In Europe, the energy efficiency of low voltage electric motors used to be classified using the voluntary Eff1/Eff2/Eff3 system. Outside Europe, other countries used to apply their own national systems, often very different to the European system. This uncertainty in standards led manufacturers to develop a harmonised international standard, and push for the issue of IEC (International Electrotechnical Commission) standard IEC 60034-30-1 “Efficiency classes of single-speed, three-phase, cage-induction motors (IE code)”.

This new standard:

- defines new classes of efficiency

IE1 (standard efficiency)

IE2 (high efficiency)

IE3 (premium efficiency)

- provides a common, international reference system for the classification of electric motors and for national legislation

- introduces a new efficiency measurement method in conformity with standard IEC 60034-1-2:2007

The following table shows the correspondence among the main classes.

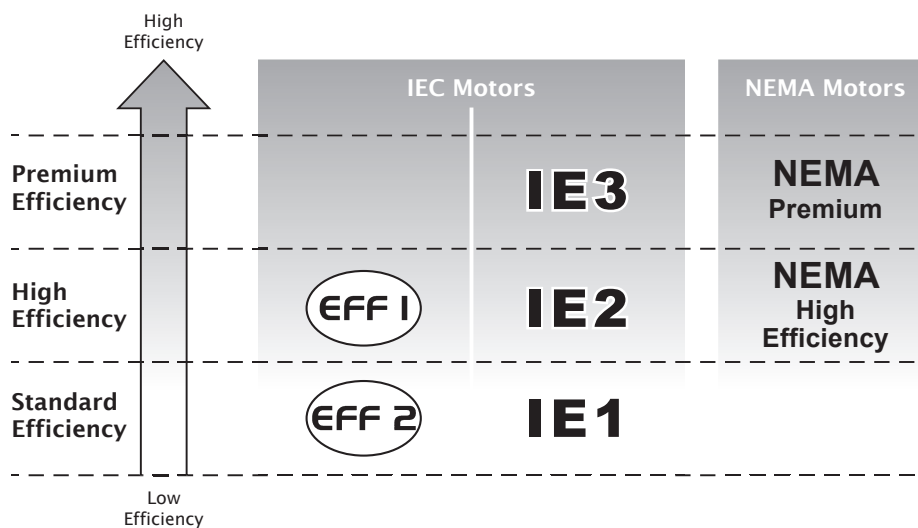

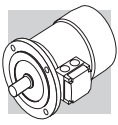

European Commission regulation 640/2009

IEC standard 60034-30-1 establishes technical guidelines for efficiency classification but does not impose any legal requirements for the adoption of any particular efficiency class. These are laid down by European Directives and national laws.

The EC Regulation applying Directive 2005/32/EC was adopted on the 22nd July 2009. This establishes the legal requirements and eco-compatible design criteria for electric motors, and imposes minimum efficiency limits according to the following schedule:

- **16/06/2011:** Electric motors must have a minimum efficiency level equivalent to class **IE2**
- **01/01/2015:** Electric motors with a rated power output between 7.5 kW and 375 kW must have a minimum efficiency level corresponding to **IE3**, or to **IE2** if controlled by an inverter.
- **01/01/2017:** Electric motors with a rated power output between 0.75 kW and 375 kW must have a minimum efficiency level corresponding to **IE3**, or to **IE2** if controlled by an inverter.

Scope and exclusions

EC Regulation 640/2009 applies to 2, 4, and 6 pole, single-speed, three-phase, 50 Hz or 60 Hz, cage-induction motors with rated outputs of 0.75 kW to 375 kW, and rated voltage up to 1000 V, designed for continuous duty (S1).

The regulation does not apply to:

- brakemotors
- motors designed to function immersed in liquid
- motors that are fully integrated in a product (like a gearbox, pump, fan), so that it is not possible to test the performance of the motor independently of that of the product.
- motors expressly designed to function:
 - at altitudes above 4000 metres a.s.l.;
 - in ambient temperatures above 60 °C;
 - at maximum operating temperatures above 400 °C;
 - in ambient temperatures below -30 °C (all motors) or below 0 °C (water-cooled motors);
 - with incoming liquid coolants at temperatures below 0 °C or above 32 °C;
 - in potentially explosive atmospheres as defined by Directive 2014/34/EU.

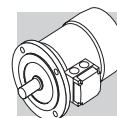

3 GENERAL CHARACTERISTICS

3.1 Production range

The asynchronous three-phase electric motors BX, BE, BN of BONFIGLIOLI RIDUTTORI's production, are available in basic designs IMB3, IMB5 and IMB14 and derived versions. Motors are the enclosed type with outer fan and cage-type rotor for use in industrial environments. Standard versions of BX/BE motors are 230/400V Δ/Y (400/690V Δ/Y in sizes BX/BE 160 and BX/BE 180), 50 Hz motors, with a tolerance of ±10%. Standard BN motors are designed to operate from a rated voltage 230/400V Δ/Y (400/690V Δ/Y for frame sizes BN 160 through BN 200) 50 Hz, with ±10% tolerance.

3.2 Standards

The motors described in this catalogue are manufactured to the applicable standards shown in the following table.

(F01)

Title	CEI	IEC
General requirements for rotating electrical machines	CEI EN 60034-1	IEC 60034-1
Terminal markings and direction of rotation of rotating machines	CEI 2-8	IEC 60034-8
Methods of cooling for electrical machines	CEI EN 60034-6	IEC 60034-6
Dimensions and output ratings for rotating electrical machines	EN 50347	IEC 60072
Classification of degree of protection provided by enclosures for rotating machines	CEI EN 60034-5	IEC 60034-5
Noise limits	CEI EN 60034-9	IEC 60034-9
Classification of type of construction and mounting arrangements	CEI EN 60034-7	IEC 60034-7
Rated voltage for low voltage mains power	CEI 8-6	IEC 60038
Vibration level of electric machines	CEI EN 60034-14	IEC 60034-14
Efficiency classes of single-speed, three-phase, cage-induction motors (IE code)	CEI EN 60034-30-1	IEC 60034-30-1
Standard method for determining losses and efficiency from tests	CEI EN 60034-2-1	IEC 60034-2-1

The motors also comply with foreign standards adapted to IEC 60034-1 as shown here below.

(F02)

DIN VDE 0530	Germany
BS5000 / BS4999	Great Britain
AS 1359	Australia
NBNC 51 - 101	Belgium
NEK - IEC 34	Norway
NF C 51	France
OEVE M 10	Austria
SEV 3009	Switzerland
NEN 3173	Netherlands
SS 426 01 01	Sweden

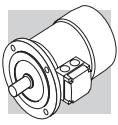

3.3 Directives 2006/95/EC (LVD) and 2004/108/EC (EMC)

BX, BE, BN motors meet the requirements of Directives 2006/95/EC (Low Voltage Directive) and 2004/108/EC (Electromagnetic Compatibility Directive) and their name plates bear the CE mark. As for the EMC Directive, construction is in accordance with standards CEI EN 60034-1, EN 61000-6-2, EN 61000-6-4.

Motors with FD brakes, when fitted with the suitable capacitive filter at rectifier input (option **CF**), meet the emission limits required by Standard EN 61000-6-3:2007 "Electromagnetic compatibility - Generic Emission Standard - Part 6-3 Residential, commercial and light industrial environment". Motors also meet the requirements of standard CEI EN 60204-1 "Electrical equipment of machines". The responsibility for final product safety and compliance with applicable directives rests with the manufacturer or the assembler who incorporate the motors as component parts.

3.4 EU Directive 2012/19/EU - Information on disposal

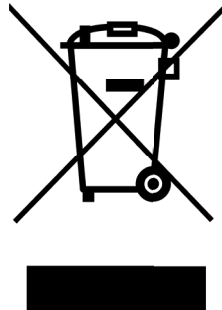

This product should not be mixed with general household waste. Disposal has to be carried out in conformity with EU Directive 2012/19/EU where established, and in accordance to national regulations.

Fulfill disposal in accordance with any other legislation in force throughout the country.

3.5 Tolerances

As per the Norms CEI EN 60034-1, applicable the tolerances here below apply to the following quantities.

(F03)	$-0.15 (1 - \eta) \quad P \leq 50\text{kW}$	Efficiency
	$-(1 - \cos\phi)/6 \quad \text{min } 0.02 \quad \text{max } 0.07$	Power factor
	$\pm 20\% *$	Slip
	+20%	Locked rotor current
	-15% +25%	Locked rotor torque
	-10%	Max. torque

(*) $\pm 30\%$ for motors with $P_n < 1 \text{ kW}$

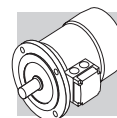

4 PREMIUM EFFICIENCY MOTOR DESIGNATION

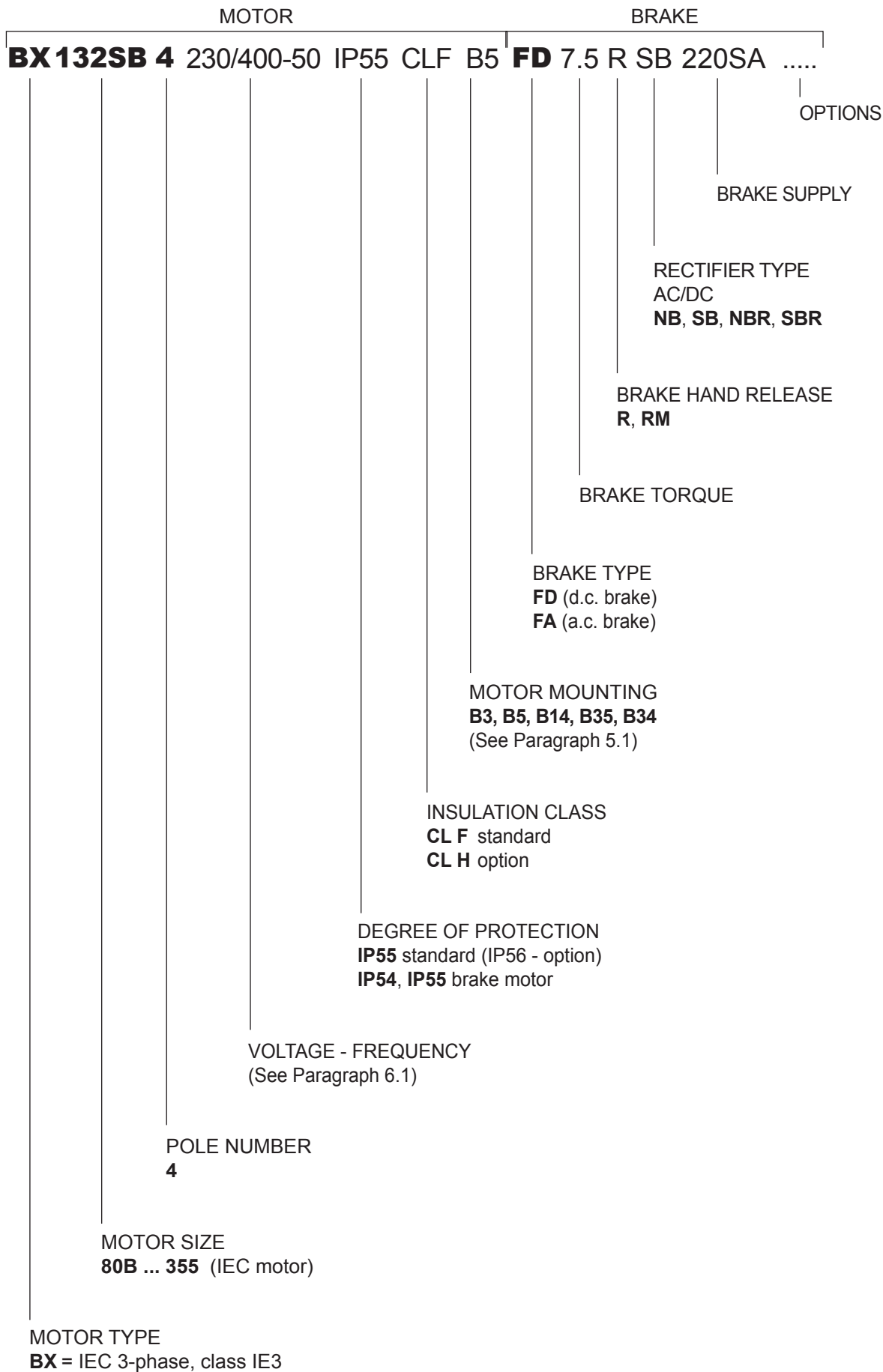

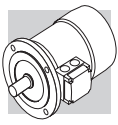

4.1 HIGH EFFICIENCY MOTOR DESIGNATION

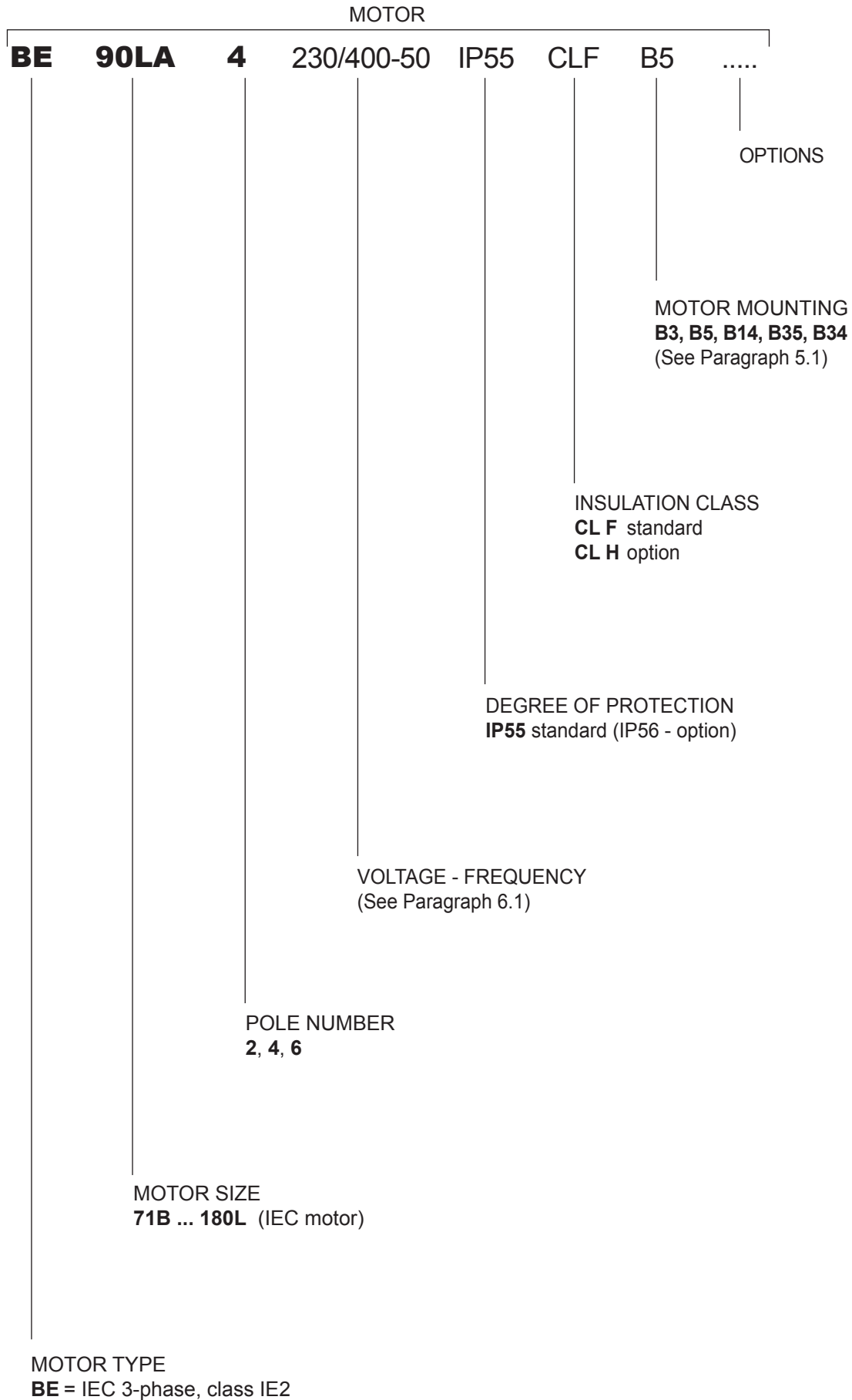

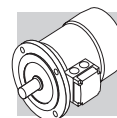

4.2 STANDARD EFFICIENCY MOTOR DESIGNATION

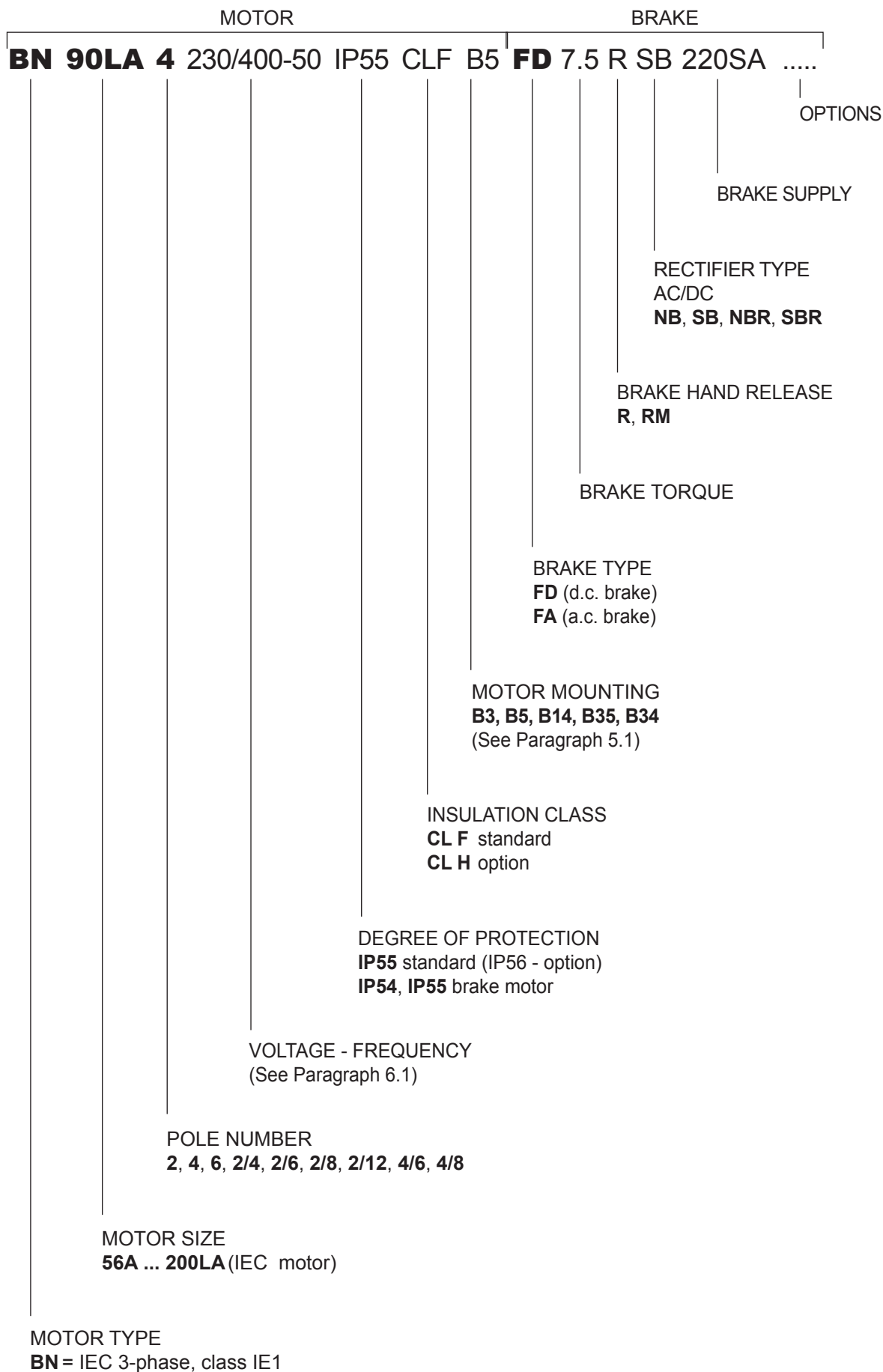

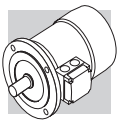

4.3 Variants

(F04)	Description	Default	Option	Page
	Voltage (BN - BE - BX) ≤ 132	230/400/50		17
	Voltage (BN - BE - BX) ≥ 160	400/690/50		
Protection class	BX - BE - BN	IP 55	IP 56	13
	BX_FD - BX_FA - BN_FD - BN_FA	IP 54	IP 55	
	BX_FD ≥ 200	IP 55		
	BX...K - BX... K_FDK	IP 55	IP 56	
Insulation class		CLF	CLH	23
Design version	BX - BE - BN	B5 B5 R	B14 B14 R	B3 12

Default values.

4.4 Options

(F05)	Description	Catalogue numbers								Availability	Page
	Thermal protective devices	D3	K1	E3						BX - BE - BN	40
	50 Hz normalized power	PN								BN	19
	Feedback devices	EN1	EN2	EN3	EN4	EN5	EN6	EN7	EN8*	BX - BE - BN	47
	Anti-condensate heaters	H1	NH1							BX - BE - BN	43
	Tropicalized windings	TP								BX - BE - BN	44
	Double-extended shaft	PS								BX - BE - BN	44
	Rotor balancing grade B	RV								BX - BE - BN	44
	External mechanical protections	RC	TC							BX - BE - BN	47
	Forced ventilation	U1	U2**							BX - BE - BN	46
	Insulated Bearings	IB*								BX	49
	Certification CSA/UL	CUS								BX - BE - BN	20
	Bureau of Indian Standard Certification	BIS								BE	21
	China Compulsory Certification	CCC								BX - BE - BN	22
	China Energy Label	CEL								BX	22
	NBR Certification	NBR								BX	23
	EECA Certification	EECA								BX	23
	Plug connector	CON								BX - BE - BN	40
	Surface protection	C_								BX - BE - BN	49
	Painting	RAL								BX - BE - BN	50
	Certificates	ACM								BX - BE - BN	51
	Inspection certificate	CC								BX - BE - BN	51
	Vertical Mounting	VM*								BX	49
	Type of duty	S2	S3	S9						BN	24

*Only for BX ≥ 200 and BX ≥ 200K

** Only for motors BN

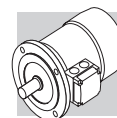

4.5 Brake-related options

(F06)

Description	Catalogue numbers				Availability	Page
Brake torque	Refer to the specific brake type					32 35
Manual release lever	R	RM			BX - BN	37
Release lever orientation	AB	AA	AC	AD	BX - BN	38
DC brake rectifier	NB	NBR	SB	SBR	BX - BN	31
Soft-start flywheel	F1				BN	39
Capacitive filter	CF				BX - BN	39
Brake separate power supply (*)	...SA	...SD			BX - BN	38
Brake functionality check	MSW				BX - BN	43
Additional cable entry for brake motors	IC				BX - BN	43

(*) Specify voltage.

Default values.

4.6 Example of identification plate

IEC EN 60034		Bonfiglioli Riduttori		CE	
3~Mot BE 90LA 4		Cod. 8U09030001			
No 1003001 - 6954785		S1 IM B5 15,1 kg			
kW 1,5		CL F IP 55 Amb 40 °C			
Hz	V ± 10%	A	min ⁻¹	cos φ	
50 ○	230/400 Δ/Y	6.1/3.5	1430	○ 0.74	
60	265/460 Δ/Y	5.4/3.1	1730	0.73	
50Hz-IE2	83.5(100%) - 83.0(75%) - 80.0(50%)				
60Hz-IE2	84.5(100%) - 83.9(75%) - 80.7(50%)				

① BONFIGLIOLI
Motor type

② Serial number

③ Rated voltage

④ Motor code

⑤ Type of duty: S1
Continuous duty

⑥ IE Class, Efficiency at:
4/4 - 3/4 - 2/4 load

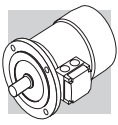

5 MECHANICAL FEATURES

5.1 Versions

BX, BE and BN motors are available in the design versions as indicated in the table below as per Standards EN 60034-7 (BX/BE), CEI EN 60034-14 (BN).

Motor reporting on nameplate the standard mounting position can be mounted in the position illustrated in the following table:

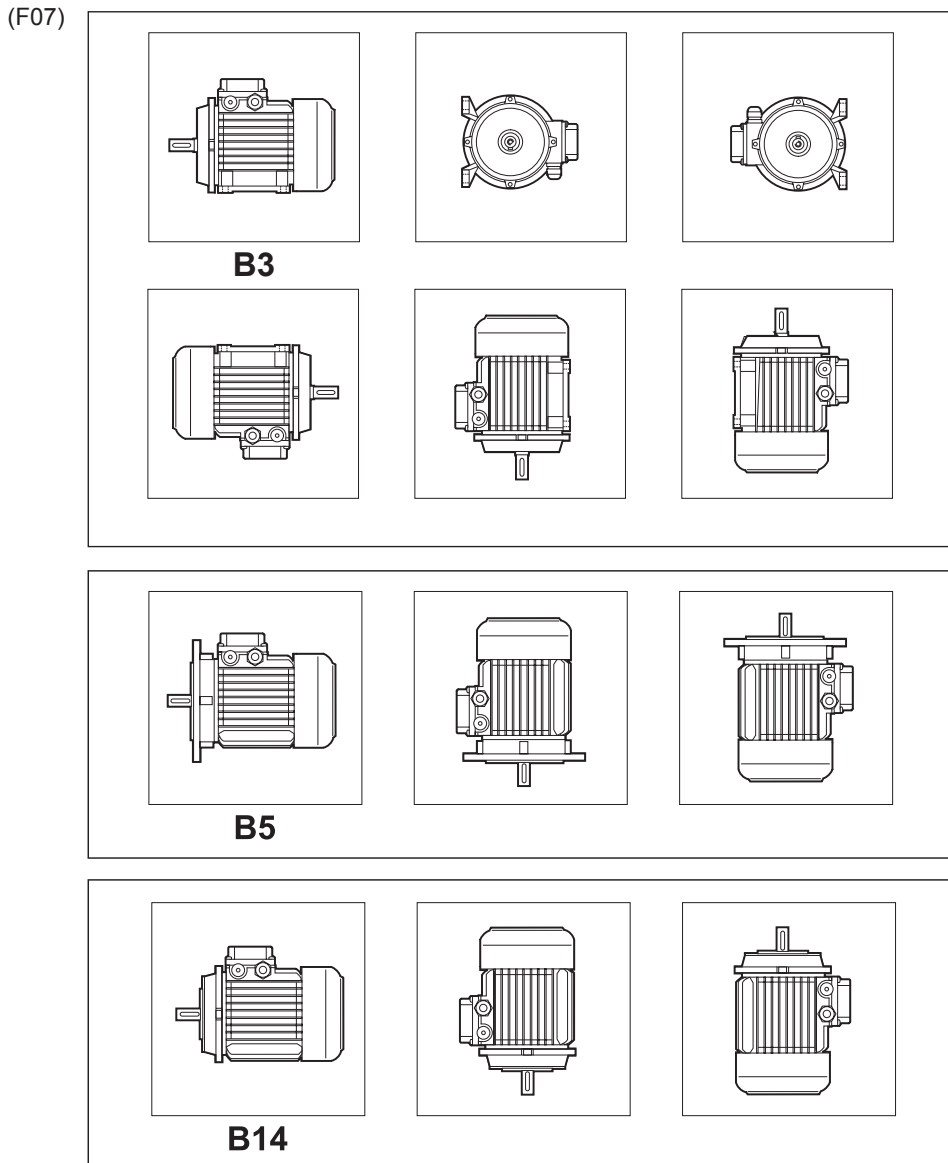

B3 mounting can be combined with B5 or B14 thus becoming B35 in the first case and B34 in the second one.

For Motor BX \geq 200 and BX \geq 200K it is necessary to select VM options when vertically mounted.

If the motor will be mounted with DE facing downwards, selection of RC option is recommended. This has to be specified during the ordering phase because not present in standard motor version.

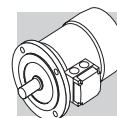

Flange output motors are also available with reduced coupling dimensions, as indicated in the table below - executions **B5R**, **B14R**.

(F08)

	BN/BE 71	BX/BE/BN 80	BX/BE/BN 90	BX/BE/BN 100	BX/BE/BN 112	BX/BE/BN 132
	DxE - Ø					
B5R ⁽¹⁾	11x23 - 140	14x30 - 160	19x40 - 200	24x50 - 200	24x50 - 200	28x60 - 250
B14R ⁽²⁾	11x23 - 90	14x30 - 105	19x40 - 120	24x50 - 140	—	—

(1) flange with through holes
(2) flange with threaded holes

5.2 Degree of protection

IP..









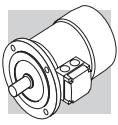



The following chart provides an overview of the degrees of protection available.

In addition to the degree of protection specified when ordering, motors to be installed outdoors require protection against direct sunlight and also – when they are to be installed vertically down – a drip cover to prevent the ingress of water and solid particles (option **RC**).

(F09)

	IP 54	IP 55	IP 56
BX - BE - BN		standard	 on request
BX ≤ 180_FD BX_FA BN_FD BN_FA	standard	 on request	
BX ≥ 200_FD BX ≥ 200K_FD		standard	
BX ≥ 280K_FD		standard	 on request

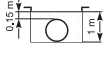
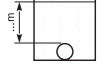

IP		5	5		
0		Not protected	0		Not protected
1		Protected against extraneous solid bodies having $\varnothing \geq 50$ mm	1		Protected against vertical water drips
2		Protected against extraneous solid bodies having $\varnothing \geq 12.5$ mm	2		Protected against vertical water drips inclined up to 15°
3		Protected against extraneous solid bodies having $\varnothing \geq 2.5$ mm	3		Protected against rain
4		Protected against extraneous solid bodies having $\varnothing \geq 1.0$ mm	4		Protected against water splashes
5		Protected against dust	5		Protected against jets of water
6		No dust ingress	6		Protected against powerful jets of water
			7		Protected against the effects of temporary immersion
			8		Protected against the effects of continuous immersion

5.3 Cooling

The motors are externally ventilated (IC 411 to CEI EN 60034-6) and are equipped with a plastic fan working in both directions.

The motors must be installed allowing sufficient space between fan cowl and the nearest wall to ensure free air intake and allow access for maintenance purposes on motor and brake, if supplied. Independent, forced air ventilation (IC 416) can be supplied on request (option **U1**).

This solution enables to increase the motor duty factor when driven by an inverter and operating at reduced speed.

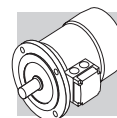

5.4 Direction of rotation

Rotation is possible in both directions. If terminals U1, V1, and W1 are connected to line phases L1, L2 and L3, clockwise rotation (looking from drive end) is obtained. For counterclockwise rotation, switch two phases.

5.5 Noise

Noise levels, measured using the method prescribed by ISO 1680 Standards, are within the maximum levels specified by Standards CEI EN 60034-9.

5.6 Vibrations and balancing

Rotor shafts are balanced with half key fitted and fall within the vibration class N, as per Standard CEI EN 60034-14.

5.7 Terminal box

Terminal board features 6 studs for eyelet terminal connection (9 studs execution for US voltage “Dual Voltage”). A ground terminal is also supplied for earthing of the equipment. Terminals number and type are shown in the following table. For brake power supply, please read par. 8 (brake FD), 9 (brake FA). In motor design IM B3, the terminal box is at the top (side opposite to feet). Brakemotors house the a.c./d.c. rectifier (factory pre-wired) inside the terminal box. Wiring instructions are provided either in the box or in the user manual.

(F10)

	No. of terminals	Terminal threads
BX 80, BX 90 BE 80, BE 90 BN 56 ... BN 90	6	M4
BX 100 ... BX 132 BE 100 ... BE 132 BN 100 ... BN 160MR	6	M5
BX 160 - BE 160 ... BE 180M BN 160M ... BN 180M	6	M6
BX 180 - BE 180L BN 180L ... BN 200L	6	M8
BX 200 ... BX 250 BX 200K ... BX 250K	6	M10
BX 280 ... BX 355 BX 280K ... BX 355K	6	M12
BX 80 ... BX 132 BE 80 ... BE 132 BN 63 ... BN 160MR	9	M4
BX 160 ... BX 180 BE 160 ... BE 180 BN 160M ... BN 200	9	M6

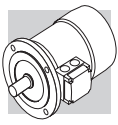

5.8 Cable entry

The holes used to bring cables to terminal boxes use metric threads in accordance with standard EN 50262 as indicated in the table here after.

(F11)

	Cable gland and dimensions		Maximum cable diameter allowed [mm]
	BN 63	2 x M20 x 1.5	1 Hole on each side
BN 71 - BE 71	2 x M25 x 1.5	17	
BX 80 - BX 90 BE 80 - BE 90 BN 80 - BN 90	2 x M25 x 1.5	17	
BX 100 - BX 112 BE 100 - BE 112 BN 100 - BN 112	2 x M32 x 1.5	2 Holes on each side	21
	2 x M25 x 1.5		17
BX 132 - BE 132 BN 132 ... BN 160MR	4 x M32 x 1.5		
BX 160 - BX 180 BE 160 - BE 180 BN 160M ... BN 200L	2 x M40 x 1.5	Pivoting, 4 x 90°	28
BX 200 ... BX 355 BX 200K ... BX 355K	2 x M63 x 1.5	Pivoting, 4 x 90°	45

5.9 Bearings

Life lubricated preloaded radial ball bearings are used, types are shown in the chart here under. Calculated endurance lifetime L_{10h} , as per ISO 281, in unloaded condition, exceeds 40000 hrs.

DE = drive end

NDE = non drive end

(F12)

	DE		NDE	
	BX, BE, BN	BX, BE, BN	BX, BE, BN	BN_FD BN_FA
BN 56	6201 2Z C3	6201 2Z C3		–
BN 63	6201 2Z C3	6201 2Z C3		6201 2RS C3
BN 71 - BE 71	6202 2Z C3	6202 2Z C3		6202 2RS C3
BX 80 - BE 80 BN 80	6204 2Z C3	6204 2Z C3		6204 2RS C3
BX 90 - BE 90 BN 90	6205 2Z C3	6205 2Z C3		6305 2RS C3
BX 100 - BE 100 BN 100	6206 2Z C3	6206 2Z C3		6206 2RS C3
BX 112 - BE 112 BN 112	6306 2Z C3	6306 2Z C3		6306 2RS C3
BX 132 - BE 132 BN 132	6308 2Z C3	6308 2Z C3		6308 2RS C3
BN 160MR	6309 2Z C3	6308 2Z C3		6308 2RS C3
BX 160M/L BE 160M/L BN 160M/L	6309 2Z C3	6309 2Z C3		6309 2RS C3
BN 180M	6310 2Z C3	6309 2Z C3		6309 2RS C3
BX 180M/L BE 180M/L BN 180L	6310 2Z C3	6310 2Z C3		6310 2RS C3

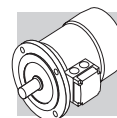

(F13)

	DE		NDE	
	BX, BE, BN	BX, BE, BN	BN_FD BN_FA	
				
BN 200L BX 200 BX 200K	6312 2Z C3 6312/C3	6310 2Z C3 6210/C3*	6310 2RS C3	
BX 225 BX 225K	6313/C3*	6212/C3*	-	
BX 250 BX 250K	6315/C3*	6213/C3*	-	
BX 280 BX 280K	6316/C3*	6316/C3*	-	
BX 315 BX 315K	6319/C3**	6316/C3**	-	
BX 355 BX 355K	6322/C3**	6316/C3**	-	

*Note: Regreasable bearings with M6x1 Greasing Device

**Note: Regreasable bearings with M10x1 Greasing Device

6 ELECTRICAL CHARACTERISTICS

6.1 Voltage

Single speed motors are provided in standard execution either for nominal voltage 230 / 400 V Δ/Y , 50 Hz, or 400 / 690 V Δ/Y , 50 Hz, with a voltage tolerance of $\pm 10\%$, according to what is specified on the below table.

Note: Motor nominal voltage/frequency also depends on the selection of options related to energy certifications for specific markets. Table below, then, has to be intended only as a guideline, for more details on the available Voltages/Frequencies as a function of the selected certification, please refer to paragraph 6.5 - 6.10.

On all the motors BN, for which the voltage / frequency configuration is not included on the below table, the voltage tolerance is reduced down to $\pm 5\%$.

For the operation out of the tolerance boundaries, the temperature may exceed by 10 K the limit provided by the adopted insulation class.

The motors are suitable for operation on distribution European grid with voltage complying with the publication IEC 60038.

(F14)

Efficiency class		V_{mot} $\pm 10\%$ 3 ~	Configuration
IE3	BX 80 ... 132	230 / 400 V - Δ/Y - 50 Hz	standard
	BX 160, BX 355	400 / 690 V - Δ/Y - 50 Hz	standard
	BX 200LAK ... BX 355MCK	460 / 800 V Δ/Y - 60 Hz	standard
IE2	BE 71 ... 132	230 / 400 V - Δ/Y - 50 Hz	standard
		460 V Y - 60 Hz ¹	standard
	BE 160, BE 180	400 / 690 V - Δ/Y - 50 Hz	At request, carries no extra charge
		400 / 690 V - Δ/Y - 50 Hz 460 V Δ - 60 Hz ¹	standard
IE1	BN 56 ... BN 132	230 / 400 V - Δ/Y - 50 Hz	standard
		400 / 690 V - Δ/Y - 50 Hz	At request, carries no extra charge
	BN 160 ... 200	460 V Y - 60 Hz	standard
		400 / 690 V - Δ/Y - 50 Hz 460 V Δ - 60 Hz	standard

¹ 4 pole motor only

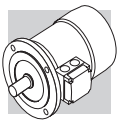

The only rated voltage for motors type at 50 Hz and all double speed motors is 400 V.
Applicable tolerances as per CEI EN 60034-1.

The table below shows the wiring options available.

(F15)



Number of poles		Winding connection
2	BE 80 ... BE 160 - BN 63 ... BN 200	Δ / Y ^(?)
4	BX 80 ... BX 355 BX 200LAK ... BX 355MCK BE 71 ... BE 180 - BN 56 ... BN 200	
6	BE 90 ... BE 160 - BN 63 ... BN 200	
8	BN 71 ... BN 132	
2/4	BN 63 ... BN 132	Δ / YY (Dahlander)
2/6	BN 71 ... BN 132	Y / Y (Two windings)
2/8	BN 71 ... BN 132	
2/12	BN 80 ... BN 132	
4/6	BN 71 ... BN 132	
4/8	BN 80 ... BN 132	Δ / YY (Dahlander)

^(?) Motors with voltage in ratio 2 (ex. 230/460 - 60) will be equipped with a 9 pin terminal box with winding connection either $\Delta \Delta / \Delta$ or YY / Y (except 6 pole BN 63 Δ / Y)

6.2 Frequency

Rated output power BN for 60 Hz operation is shown in the following diagram.

(F16)

	P_n [kW]					P_n [kW]			
	2P	4P	6P	8P		2P	4P	6P	8P
BN 56A	–	0.07	–	–	BN 100L	3.5	–	–	–
BN 56B	–	0.10	–	–	BN 100LA	–	2.5	1.8	0.85
BN 63A	0.21	0.14	0.10	–	BN 100LB	4.7	3.5	2.2	1.3
BN 63B	0.30	0.21	0.14	–	BN 112M	4.7	4.7	2.5	1.8
BN 63C	0.45	0.30	–	–	BN 132S	–	6.5	3.5	2.5
BN 71A	0.45	0.30	0.21	0.10	BN 132SA	6.5	–	–	–
BN 71B	0.65	0.45	0.30	0.14	BN 132SB	8.7	–	–	–
BN 71C	0.90	0.65	0.45	–	BN 132M	11	–	–	3.5
BN 80A	0.90	0.65	0.45	0.21	BN 132MA	–	8.7	4.6	–
BN 80B	1.30	0.90	0.65	0.30	BN 132MB	–	11	6.5	–
BN 80C	1.80	1.3	0.90	–	BN 160MR	12.5	12.5	–	–
BN 90S	–	1.3	0.90	0.45	BN 160MB	17.5	–	–	–
BN 90SA	1.8	–	–	–	BN 160M	–	–	8.6	–
BN 90SB	2.2	–	–	–	BN 160L	21.5	17.5	12.6	–
BN 90L	2.5	–	1.3	0.65	BN 180M	24.5	21.5	–	–
BN 90LA	–	1.8	–	–	BN 180L	–	25.3	17.5	–
BN 90LB	–	2.2	–	–	BN 200L	–	34	–	–
					BN 200LA	34	–	22	–

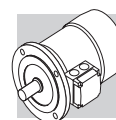

BX and BE motors are available at 60 Hz on a 4 pole configuration only, and their power rating is the same as their 50 Hz counterpart. Double speed BN motors supplied at 60 Hz will have an increase of nominal power, referred to 50 Hz, equal to 15%, whereas double speed BX / BE motors are not available. If a nominal power rating, equal to the normalised nominal power rating at 50 Hz, was requested to be on a nameplate of a motor meant to be voltage supplied at 60 Hz, the PN option shall be specified on the motor designation. Motors normally designed for a 50 Hz frequency may be used on a 60 Hz operating grid, but the related data shall be updated according to the following table.

Motors designated for 50 Hz operation show on the nameplate also the values for 60 Hz operation (excluding motors in CUS execution and brake motors). See the following table.

(F17)

	50 Hz	60 Hz			
	V - 50 Hz	V - 60 Hz	P _n - 60 Hz	M _n , M _a /M _n - 60 Hz	n [min ⁻¹] - 60 Hz
BX/BE	230/400 Δ/Y	265 - 460 Δ Y	1	0.83	1.2
	400/690 Δ/Y	460 Δ			
BN	230/400 Δ/Y	220 - 240 Δ			
		380 - 415 Y			
	400/690 Δ/Y	380 - 415 Δ			
BN	230/400 Δ/Y	265 - 280 Δ			
		440 - 480 Y			
	400/690 Δ/Y	440 - 480 Δ			

6.3 Ambient temperature

Catalogue rating values are calculated for 50 Hz operation and for standard ambient conditions (temperature 40 °C; elevation ≤ 1000 m a.s.l.) as per the CEI EN 60034-1 Standards.

The motors can be used within the 40 - 60 °C temperature range with rated power output adjusted by factors given in the table below.

(F18)

Ambient temperature (°C)	40°	45°	50°	55°	60°
Permitted power as a % of rated power	100%	95%	90%	85%	80%

Should a derating factor higher than 15% apply please consult factory.

6.4 50 HZ normalized power

PN

With this option, motor name plate includes 50 Hz normalized power information even when motor is designated for operation with 60 Hz power mains. For 60 Hz supplies along with voltages 230/460V and 575V the PN option is applied by default.

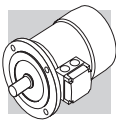

6.5 Motors certified for USA and Canada

CUS

CUS option is available in NEMA Design C execution for BN and BE motors, and NEMA Design B for BX motors, with regards to the electrical features. Motors are certified in compliance with CSA (Canadian Standard) C22.2 N° 100 and UL (Underwriters Laboratory) UL 1004-1 standards, as stated on UL file E308649.

BN and BE motors nameplates show the below marks:



BX≤180 motors nameplates show the below marks and are certified in compliance with the energy efficiency standards in effect in the USA and Canada, respectively provided by DOE (10 CFR Part 431) and NRCAN (Energy Efficiency Regulations), tested according to CSA C390 standard.



BX 100 motors are available for the USA only and not for Canada, and the related marks reported on the nameplates are the following:



BX≥200K motors shows on nameplate the logo reported below and are compliant to energy efficiency regulations of USA and Canada, respectively established from DOE (10 CFR Part 431) and from NRCAN (Energy Efficiency Regulations), and tested in accordance to CSA C390.



NOTES:

Starting from **June, 1st 2016**, CUS motors whose efficiency is below IE3 (i.e. “Premium Efficiency”) cannot be any longer sold in the USA and Canada, unless one or more of the following conditions apply:

- Double speed motors;
- Motors plated for a non - continuous duty (<80%);
- Motors intended to be operated through variable frequency drive only (properly equipped with “Inverter Duty Only” label, or similar).

CUS option is selectable in combination to U1 or U2 only for BX≥200K.

US power mains voltages and the corresponding rated voltages to be specified for the motor are indicated in the following table:

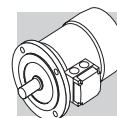

(F19)

Frequency	Mains voltage	V_{mot}
60 Hz	208 V	200 V
	240 V	230 V
	480 V	460 V
	600 V	575 V

BX motor with CUS option are available with the following nominal Voltage/Frequency combinations:

(F20)

	V_{mot}
BX \leq 132	265/460 - 60 Hz
BX \leq 180	230/460 - 60 Hz 330/575 - 60 Hz
BX \geq 160 BX \geq 200K	460/800 - 60 Hz

CUS option is applicable onto 50 Hz operating motors as well (motors BX excluded).

Motors with voltage in ratio 2 (e.g. 230/460-60; 220/440-60) feature, as standard, a 9-stud terminal board. For same executions, as well as for 575V-60Hz supply, the nominal rating is coincident with the correspondent 50Hz rating.

For DC brake motors type FD, the rectifier is connected to a single-phase 230 VAC supply voltage in the motor terminal box.

Brake power supply for brake motors is as follows:

6.6 Motors certified for India

BIS

Low voltage motors ≥ 0.37 kW manufactured or imported in India must be certified from Bureau of Indian Standard and provided with a mark certifying motor compliance to IS 12615 standard.

BE motors with power from 0.37 to 3.7 kW included are available with the above mentioned certification and, when BIS option is selected, are provided with the nameplate reporting the following logo:



BE motor with BIS option are available with the following nominal Voltage/Frequency combinations:

(F21)

	V_{mot}
71 \leq BE \leq 112	230/400 - 50 Hz

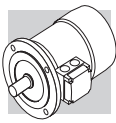

6.7 China Compulsory Certification

CCC

Electric motors destined for sale in the People's Republic of China have to be certified under the CCC (China Compulsory Certification) system. BN motors of up to 7 Nm in rated torque are available with CCC certification and a special nameplate bearing the mark shown below:



CCC option is not currently available for IE3 motors.

CCC option is not currently available for servo - ventilated motors.

6.8 Motor certified for China (China Energy Label)

CEL

Low voltage motors $\geq 0.75\text{kW}$ manufactured or imported in China must be certified and registered by the label office and provided with an energy label certifying they meet the energy efficiency levels as defined in GB18613-2012.

BX motors with power from 30 to 355kW included are available with the above mentioned certification and, when CEL option is selected, are provided with the following sticker applied to the motor:

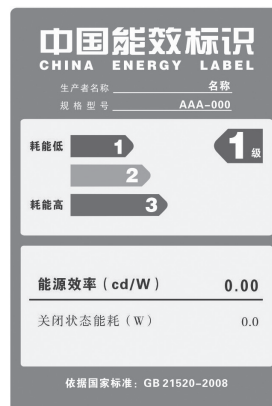

BX motors with CEL option are available with the following nominal Voltage/Frequency combinations:

(F22)		V_{mot}
	BX ≥ 200	380/660 - 50 Hz

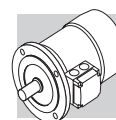

6.9 Motors certified for Brazil

NBR

Brazilian laws regulamentates the manufacturing and importation of electric motor in the country. These have to be approved by NBR trough a declaration of the motor efficiency level at INMETRO. Motor compliant to NBR must report the declared efficiency value and have to be provided with a specific NBR nameplate and the additional mark shown in picture below:

NBR option is available for BX ... K motors with power from 30 to 355kW included



BX motors with NBR option are available with the following nominal Voltage/Frequency combinations:

(F23)

	V_{mot}
BX \geq 200K	440/760 - 60 Hz

6.10 Motors certified for Australia

EECA

Electric motor covered by Australian/NewZeland's energy regulation must be listed in the national database Energyratig. Mootr with EECA option are registered in the previously mentioned database and can be sold in Australia and New Zeland.

EECA option is available for BX ... K motor with power from 30 to 355kW included.

BX motors with EECA option are available with the following nominal Voltage/Frequency combinations:

(F24)

	V_{mot}
BX \geq 200K	400/690 - 50 Hz

6.11 Insulation class

CL F

Bonfiglioli motors use class **F** insulating materials (enamelled wire, insulators, impregnation resins) as compare to the standard motor.

In standard motors, stator windings over temperature normally stays below the 80 K limit corresponding to class B over temperature.

A careful selection of insulating components makes the motors compatible with tropical climates and normal vibration.

For applications involving the presence of aggressive chemicals or high humidity, contact Bonfiglioli Engineering for assistance with product selection.

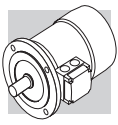

CL H

Motors manufactured in insulation class **H** are available at request.

This option can be selected for motors compliant with CSA and UL standards (CUS option), only for BX≥200 and BX≥200K.

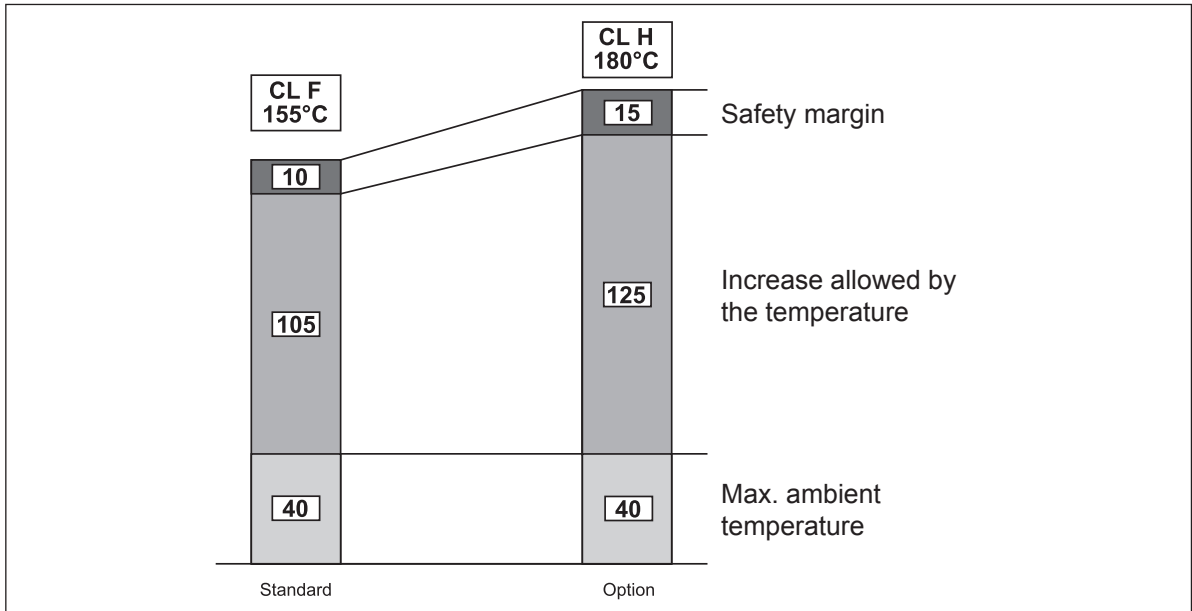

6.12 Type of duty

Unless otherwise specified, catalogue motor power refers to continuous duty S1. Any operating conditions other than S1 duty must be identified in accordance with duty cycle definitions laid down in standards CEI EN 60034-1. For duty cycles S2 and S3, the power increase co-efficient reported in the following table may be used. Please note that the table provided below applies to single-speed motors. As an alternative to S1 continuous duty, one of the following values can be specified at the product configuration stage (single speed motors only): S2, S3 or S9. The motor nameplate will be marked with an increased power rating to suit the type of duty, and with specific electrical data and a duty type of S2-30 min, S3-70% or S9 respectively. For further details, contact Bonfiglioli's Technical Service. Please contact Bonfiglioli Engineering for the power increase coefficients applicable to switch-pole motors.

(F25)

	Type of duty						Contact us
	S2			S3 *			
	Duration (min)			Intermittence (I)			
	10	30 (*)	60	25%	40%	70% (*)	
f_m	1.35	1.15	1.05	1.25	1.15	1.1	

* Cycle duration must, in any event, be equal to or less than 10 minutes; if this time is exceeded, please contact our Technical Service.

(*) Default values from options (tab. F05).

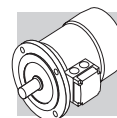

6.12.1 Cyclic duration factor:

$$I = \frac{t_f}{t_f + t_r} \cdot 100 \quad (01)$$

t_f = work time under constant load

t_r = rest time

6.12.2 Limited duration duty S2

This type of duty is characterized by operation at constant load for a limited time, which is shorter than the time required to reach thermal equilibrium, followed by a rest period of sufficient duration to restore ambient temperature in the motor.

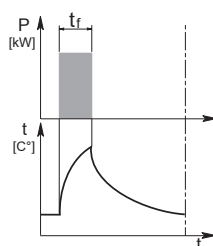

6.12.3 Periodical intermittent duty S3:

This type of duty is characterized by a sequence of identical operation cycles, each including a constant load operation period and a rest period.

For this type of duty, the starting current does not significantly influence overtemperature.

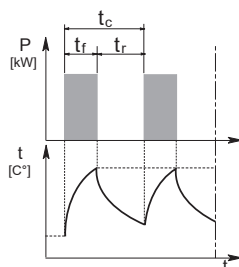

6.13 Inverter-controlled motors

The electric motors Bonfiglioli may be used in combination with PWM inverters with rated voltage at transformer input up to 500 V. Standard motors use a phase insulating system with separators, class 2 enamelled wire and class H impregnation resins (1600V peak-to-peak voltage pulse capacity and rise edge $t_s > 0.1\mu s$ at motor terminals). Typical torque/speed curves referred to S1 duty for motors with base frequency $f_b = 50$ Hz is are reported in the table below.

Because ventilation is somewhat impaired in operation at lower frequencies (about 30 Hz), standard motors with incorporated fan (IC411) require adequate torque derating or - alternately - the addition of a separate supply fan cooling.

Above base frequency, upon reaching the maximum output voltage of the inverter, the motor enters a steady-power field of operation, and shaft torque drops with ratio (f/f_b) .

As motor maximum torque decreases with $(f/f_b)^2$, the allowed overloading must be reduced progressively.

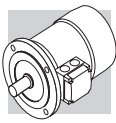

(F26)

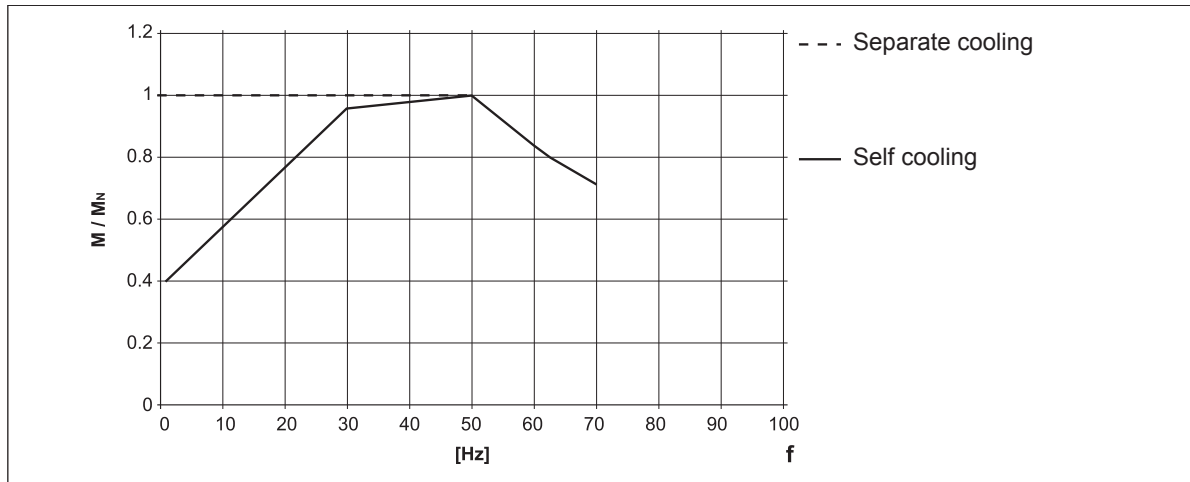

The following table reports the mechanical speed limit for motors operating above rated frequency:

(F27)

	n [min ⁻¹]		
	2p	4p	6p
≤ BE 112 - BN 112	5200	4000	3000
≥ BE 132 - BN 132	4500	4000	3000
BX 80 ... BX 180		4000	
BX 200		4500	
BX 225 ... BX 250		3600	
BX 280		2000	
BX 315 ... BX 355		2200	

Above rated speed, motors generate increased mechanical vibration and fan noise. Class B rotor balancing is highly recommended in these applications. Installing a separate supply fan cooling may also be advisable.

Remote-controlled fan and brake (if fitted) must always be connected direct to mains power supply.

6.14 Permissible starts per hour, Z

The rating charts of brakemotors lend the permitted number of starts Z_0 , based on 50% intermittence and for unloaded operation. The catalogue value represents the maximum number of starts per hour for the motor without exceeding the rated temperature for the insulation class F. To give a practical example for an application characterized by inertia J_c , drawing power P_r and requiring mean torque at start-up M_L the actual number of starts per hour for the motor can be calculated approximately through the following equation:

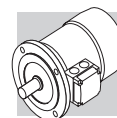

$$Z = \frac{Z_0 \cdot K_c \cdot K_d}{K_J} \quad (02)$$

where:

$$K_J = \frac{J_m + J_c}{J_m} \quad \text{inertia factor}$$

$$K_c = \frac{M_a - M_L}{M_a} \quad \text{torque factor}$$

$$K_d = \quad \text{load factor, see the following table}$$

(F28)

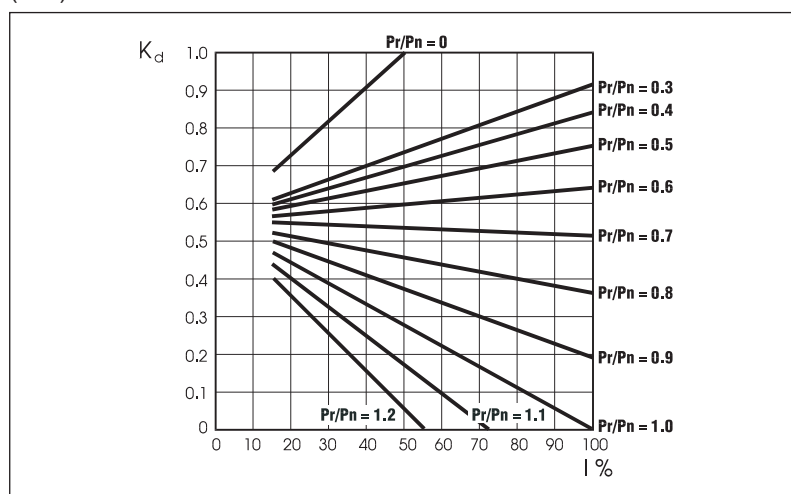

If actual starts per hour is within permitted value (Z) it may be worth checking that braking work is compatible with brake (thermal) capacity W_{max} also given in the tables (F35), (F43) and dependent on the number of switches (c/h).

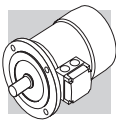

7 ASYNCHRONOUS BRAKE MOTORS

7.1 Operation

Versions with incorporated brake use spring-applied DC (FD option) or AC (FA options) brakes. All brakes are designed to provide fail-safe operation, meaning that they are applied by spring-action in the event of power failure.

(F29)

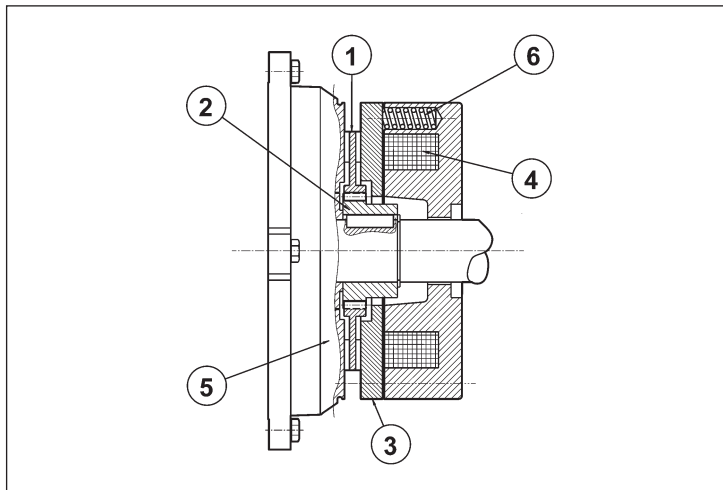

Key:

- ① brake disc
- ② disc carrier
- ③ pressure plate
- ④ brake coil
- ⑤ motor rear shield
- ⑥ brake springs

When voltage is interrupted, pressure springs push the armature plate against the brake disc. The disc becomes trapped between the armature plate and motor shield and stops the shaft from rotation. When the coil is energized, a magnetic field strong enough to overcome spring action attracts the armature plate, so that the brake disc – which is integral with the motor shaft – is released.

7.2 Most significant features

- High braking torques (normally $M_b \approx 2 M_n$), braking torque adjustment.
- Steel brake disc with double friction lining (low-wear, asbestos-free lining).
- Hexagonal seat on motor shaft fan end (N.D.E.) for manual rotation (not compatible with options PS, RC, TC, U1, U2, EN1, EN2, EN3, EN4, EN5, EN6).
- Manual release lever (options **R** and **RM** for FD; option **R** for FA).
- Corrosion-proof treatment on all brake surfaces.
- Insulation class F.

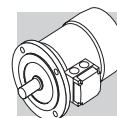

8 DC BRAKE MOTORS TYPE BX_FD - BN_FD

Frame sizes: BX 80 ... BX 355M, BX200LAK ... BX355MCK - BN 63 ... BN 200L

BE motors may be available equipped with the FD brake, for further information please contact our Technical Department.

(F30)

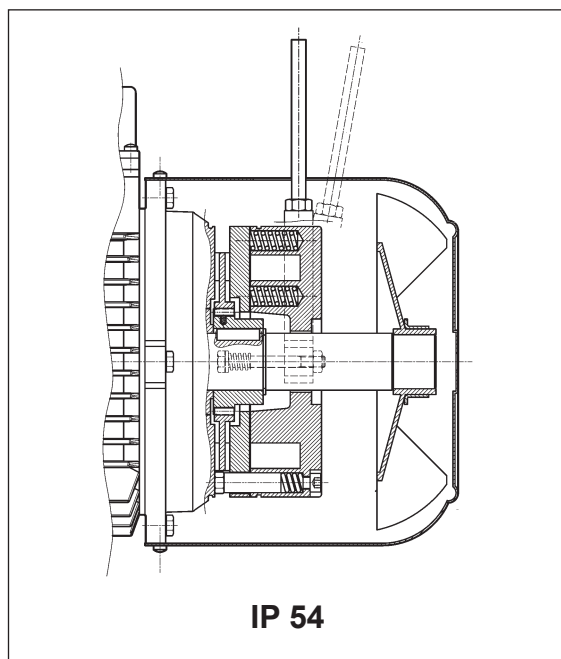

(F31)

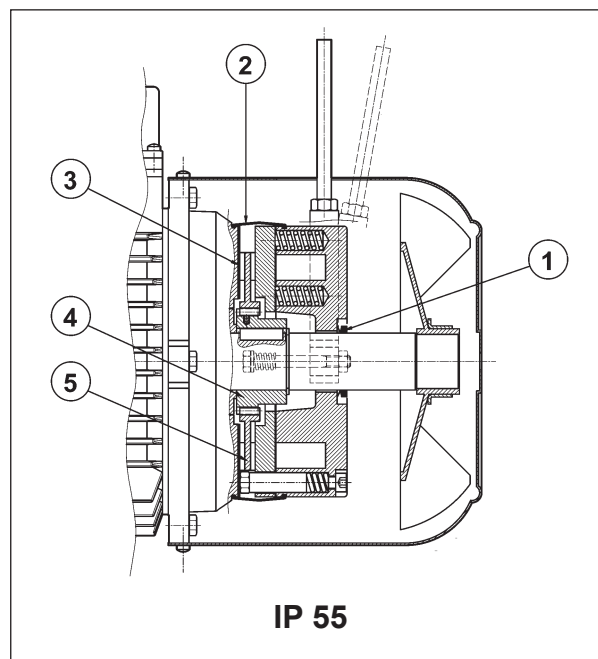

Direct current toroidal-coil electromagnetic brake bolted onto motor shield. Preloading springs provide axial positioning of magnet body.

Brake disc slides axially on steel hub shrunk onto motor shaft with anti-vibration device.

Brake torque factory setting is indicated in the corresponding motor rating charts. Braking torque may be modified by changing the type and/or number of springs.

At request, motors may be equipped with manual release lever with automatic return (**R**) or system for holding brake in the released position (**RM**).

See variant at paragraph "BRAKE RELEASE SYSTEMS" for available release lever locations.

FD brakes ensure excellent dynamic performance with low noise. DC brake operating characteristics may be optimized to meet application requirements by choosing from the various rectifier/power supply and wiring connection options available.

For applications involving lifting and/or high hourly energy dissipation, contact Bonfiglioli's Technical Service.

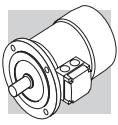

8.1 Degree of protection

The standard protection degree for BN and BX≤180 is IP54, while for BX≥200 and BX BX≥200K standard protection degree is IP55.

BN and BX≤180 brakemotor with a standard protection degree IP54 can be requested with a protection degree IP55. If **IP55** is selected the following construction variants will be applied:

- ① V-ring at N.D.E. of motor shaft
- ② dust and water-proof rubber boot
- ③ stainless steel ring placed between motor shield and brake disc
- ④ stainless steel hub
- ⑤ stainless steel brake disc

8.2 FD brake power supply

A rectifier accommodated inside the terminal box feeds the DC brake coil. Wiring connection across rectifier and brake coil is performed at the factory.

On all single-pole motors, rectifier is connected to the motor terminal board.

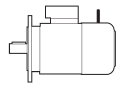

Rectifier standard power supply voltage V_B is as indicated in the following table, regardless of mains frequency:

(F32)

2, 4, 6 P			1 speed		
	BX_FD - BN_FD $V_{mot} \pm 10\%$ 3 ~		$V_B \pm 10\%$ 1 ~	brake connected to terminal board power supply	separate power supply
BX 80...BX 132 BN 63...BN 132	230/400 V – 50 Hz	230 V	standard		specify V_B SA o V_B SD
BX 160...BX 180 BN 160...BN 200	400/690 V – 50 Hz	400 V	standard		specify V_B SA o V_B SD

Switch-pole motors feature a separate power supply line for the brake with rectifier input voltage V_B as indicated in the table below:

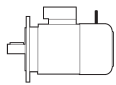
(F33)

2/4, 2/6, 2/8, 2/12, 4/6, 4/8 P			2 speed		
	BN_FD $V_{mot} \pm 10\%$ 3 ~		$V_B \pm 10\%$ 1 ~	brake connected to terminal board power supply	separate power supply
BN 63...BN 132	400 V – 50 Hz	230 V			specify V_B SA o V_B SD

The diode half-wave rectifier ($V_{DC} \approx 0,45 \times V_{AC}$) is available in versions **NB**, **SB**, **NBR** e **SBR**, as detailed in the table below:

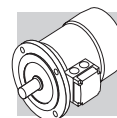

(F34)

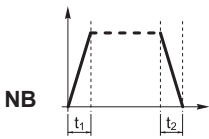
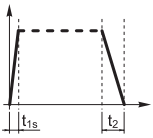
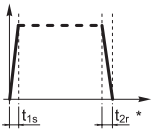
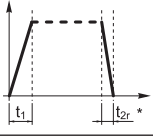
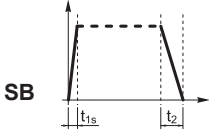
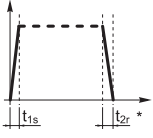
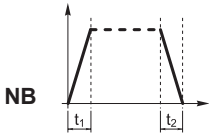
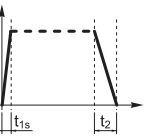
	brake		
		standard	at request
BN 63	FD 02		 SB  SBR  NBR
BN 71	FD 03 FD 53		
BX 80 - BN 80	FD 04		
BX 90S - BN 90S	FD 14		
BX 90L - BN 90L	FD 05		
BX 100 - BN 100	FD 15		
BX 112 - BN 112	FD 06S		 SBR
BX 132 - BN 132 - BN 160MR	FD 56 FD 06 FD 07		
BX 160 - BN 160L - BN 180M	FD 08		
BX 180 - BN 180L - BN 200M	FD 09		
BX 200LA	FD 20		
BX225SA	FD 25		
BX250M - BX315SA	FD 30		 SB
BX315SB - BX315SC	FD 160		
B315MA - BX355MA	FD 250		
BX355MB - BX355MC	FD 400		
BX200LAK	FD 8		
BX225SAK - BX225SBK	FD 9		
BX250MAK	FD 10		
BX280SAK - BX315SAK	FD 1000		
BX315SBK - BX315SCK	FD 1600		
BX355SAK - BX355MCK	FD 2500		
		⊖	⊖

(*) $t_{2c} < t_{2r} < t_2$

Rectifier **SB** with electronic energizing control over-energizes the electromagnet upon power-up to cut brake release response time and then switches to normal half-wave operation once the brake has been released.

Use of the **SB** rectifier is mandatory in the event of:

- high number of operations per hour
- reduced brake release response time
- brake is exposed to extreme thermal stress

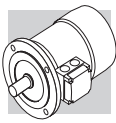

Rectifiers **NBR** or **SBR** are available for applications requiring quick brake intervention (braking condition reinstatement) response.

These rectifiers complement the **NB** and **SB** types as their electronic circuit incorporates a static switch that de-energizes the brake quickly in the event voltage is missing. This arrangement ensures short brake release response time with no need for additional external wiring and contacts.

Optimum performance of rectifiers **NBR** and **SBR** is achieved with separate brake power supply.

Versions available: 230Vac ±10%, 400Vac ± 10%, 50/60 Hz (with power supply); 100Vdc ±10%, 180Vdc ± 10% (with SD option).

8.3 FD brake technical specifications

The table below reports the technical specifications of DC brakes FD.

(F35)

Brake	Brake torque M_b [Nm]			Release		Braking		W_{max} per brake operation			W	P
	springs			t_1 [ms]	t_{1s} [ms]	t_2 [ms]	t_{2c} [ms]	[J]				
	6	4	2					10 s/h	100 s/h	1000 s/h		
FD02	–	3.5	1.75	30	15	80	9	4500	1400	180	15	17
FD03	5	3.5	1.75	50	20	100	12	7000	1900	230	25	24
FD53	7.5	5	2.5	60	30	100	12					
FD04	15	10	5	80	35	140	15	10000	3100	350	30	33
FD14												
FD05	40	26	13	130	65	170	20	18000	4500	500	50	45
FD15	40	26	13	130	65	170	20					
FD06S	60	40	20	–	80	220	25	20000	4800	550	70	55
FD56	–	75	37	–	90	250	20	29000	7400	800	80	65
FD06		100	50		100	250	20					
FD07	150	100	50	–	120	200	25	40000	9300	1000	130	65
FD08*	250	200	170	–	140	350	30	60000	14000	1500	230	100
FD09**	400	300	200	–	200	450	40	70000	15000	1700	230	120
FD20	260			100	170	340	–	80000	1700	1800	–	100
FD25	400			120	195	390	–	120000	19000	2000	–	110
FD30	1000			180	210	420	–	200000	28000	2900	–	200
FD160	1600			360	245	490	–	240000	36000	2600	–	336
FD250	2500			420	343	685	–	280000	47000	3700	–	400
FD400	4000			530	455	910	–	325000	51000	4500	–	420
FD8	400			176	78	236	–	65000	7000	650	–	85
FD9	600			324	138	176	–	120000	12000	1200	–	100
FD10	800			480	194	172	–	100000	16000	2000	–	150
FD1000	1000			252	–	375	–	220000	27000	2700	–	300
FD1600	1600			366	–	498	–	230000	35000	3500	–	340
FD2500	2500			660	–	880	–	590000	61000	6100	–	530

* brake torque values obtained with 9, 7 and 6 springs, respectively

** brake torque values obtained with 12, 9 and 6 springs, respectively

t_1 = brake release time with half-wave rectifier
 t_{1s} = brake release time with over-energizing rectifier
 t_2 = brake engagement time with AC line interruption and separate power supply
 t_{2c} = brake engagement time with AC and DC line interruption – Values for t_1 , t_{1s} , t_2 , t_{2c} indicated in the tab. (F30) are referred to brake set at maximum torque, medium air gap and rated voltage
 W_{max} = max energy per brake operation
W = braking energy between two successive air gap adjustments
 P_b = brake power absorption at 20 °C
 M_b = static braking torque (±15%)
s/h = starts per hour

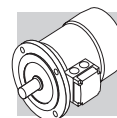

The brake pad wear depends on the operating/ambient conditions (temperature, humidity, angular speed, specific pressure); Therefore the declared wear rate must be considered as indicative.

8.4 FD brake connections

On standard single-pole motors, the rectifier is connected to the motor terminal board at the factory. For switch-pole motors and where a separate brake power supply is required, connection to rectifier must comply with brake voltage VB stated in motor name plate.

Because the load is of the inductive type, brake control and DC line interruption must use contacts from the usage class AC-3 to IEC 60947-4-1.

Table (F36) – Brake power supply from motor terminals and AC line interruption

Delayed stop time t_2 and function of motor time constants.

Mandatory when soft-start/stops are required.

Table (F37) – Brake coil with separate power supply and AC line interruption

Normal stop time independent of motor.

Achieved stop times t_2 are indicated in the table (F35).

Table (F38) – Brake coil power supply from motor terminals and AC/DC line interruption.

Quick stop with operation times t_{2c} as per table (F35).

Table (F39) – Brake coil with separate power supply and AC/DC line interruption.

Stop time decreases by values t_{2c} indicated in the table (F35).

The brake may be voltage supplied directly from the motor terminal box (from tab. F36 to tab. F35) only if the nominal voltage of the brake is the same as the smaller voltage of the motor.

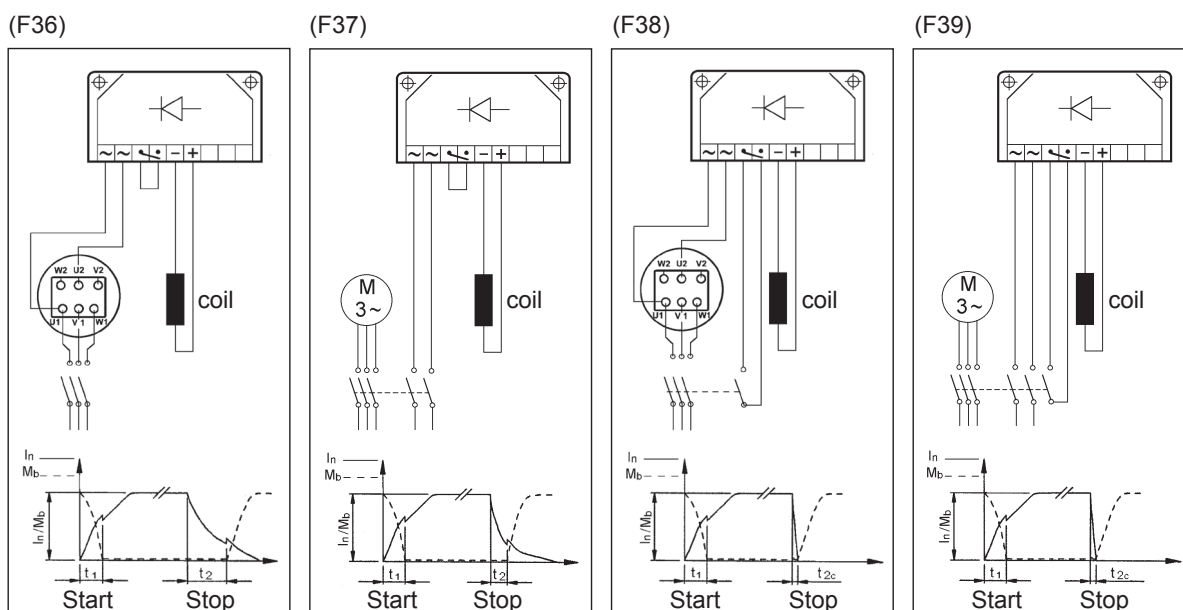

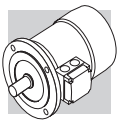

9 AC BRAKE MOTORS TYPE BX_FA - BN_FA

Frame sizes: BX 80 ... BX 160L - BN 63 ... BN 180M

(F40)

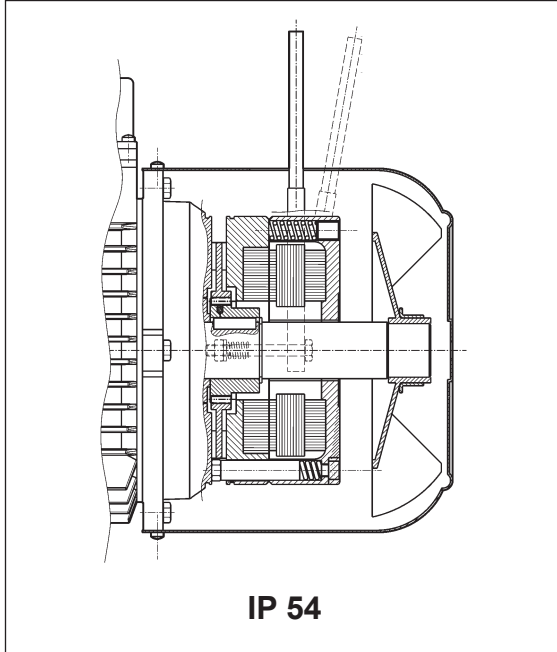

IP 54

(F41)

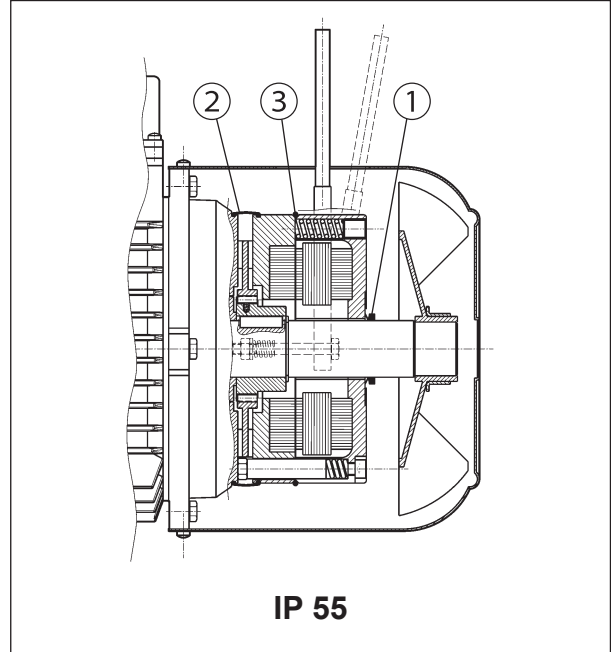

IP 55

Electromagnetic brake operates from three-phase alternated current power supply and is bolted onto conveyor shield. Preloading springs provide axial positioning of magnet body.

Steel brake disc slides axially on steel hub shrunk onto motor shaft with anti-vibration device.

Brake torque factory setting is indicated in the corresponding motor rating charts.

Spring preloading screws provide stepless braking torque adjustment.

Torque adjustment range is $30\% M_{bMAX} < M_b < M_{bMAX}$ (where M_{bMAX} is maximum braking torque as shown in tab. (F43).

Thanks to their high dynamic characteristics, FA brakes are ideal for heavy-duty applications as well as applications requiring frequent stop/starts and very fast response time.

Motors may be equipped with manual release lever with automatic return (R) at request. See variant at paragraph "BRAKE RELEASE SYSTEMS" for available release lever locations.

For applications involving lifting and/or high hourly energy dissipation, contact Bonfiglioli's Technical Service.

9,1 Degree of protection

Standard protection class is IP54.

Brake motor FA is also available in protection class **IP55**, which mandates the following variants:

- ① V-ring at N.D.E. of motor shaft
- ② dust and water-proof rubber boot
- ③ O-ring

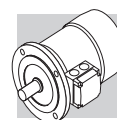

9,2 FA brake power supply

In single speed motors, power supply is brought to the brake coil direct from the motor terminal box. As a result, brake voltage and motor voltage are the same. In this case, brake voltage indication may be omitted in the designation.

Switch-pole motors and motors with separate brake power supply feature an auxiliary terminal board with 6 terminals for connection to brake line. In both cases, brake voltage indication in the designation is mandatory. The following table reports standard AC brake power supply ratings for single- and switch-pole motors:

(F42)

single-pole motor	BX 80...BX 132 BN 63...BN 132	BX 160 BN 160...BN 180
	230Δ / 400Y V ±10% – 50 Hz	400Δ/ 690Y V ±10% – 50 Hz
	265Δ / 460Y ±10% - 60 Hz	460Y – 60 Hz

switch-pole motors (separate power supply line)	BN 63...BN 132
	230Δ / 400Y V ±10% – 50 Hz
	460Y - 60 Hz

Unless otherwise specified, standard brake power supply is 230Δ /400Y V - 50 Hz.

Special voltages in the 24...690 V, 50-60 Hz range are available at request.

9,3 Technical specifications of FA brakes

(F43)

Brake	Brake torque M_b [Nm]	Release t_1 [ms]	Braking t_2 [ms]	W_{max} [J]			W [MJ]	P [VA]
				10 s/h	100 s/h	1000 s/h		
FA 02	3.5	4	20	4500	1400	180	15	60
FA 03	7.5	4	40	7000	1900	230	25	80
FA 04	15	6	60	10000	3100	350	30	110
FA 14								
FA 05	40	8	90	18000	4500	500	50	250
FA 15								
FA 06S	60	16	120	20000	4800	550	70	470
FA 06	75	16	140	29000	7400	800	80	550
FA 07	150	16	180	40000	9300	1000	130	600
FA 08	250	20	200	60000	14000	1500	230	1200

M_b = max static braking torque (±15%)

t_1 = brake release time

t_2 = brake engagement time

W_{max} = max energy per brake operation (brake thermal capacity)

W = braking energy between two successive air gap adjustments

P_b = power drawn by brake at 20° (50 Hz)

s/h = starts per hour

NOTE

Values t_1 and t_2 in the table refer to a brake set at rated torque, medium air gap and rated voltage.

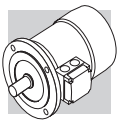

The brake pad wear depends on the operating/ambient conditions (temperature, humidity, angular speed, specific pressure); Therefore the declared wear rate must be considered as indicative.

9,4 FA brake connections

The diagram below shows the wiring when brake is connected directly to same power supply of the motor:

(F44)

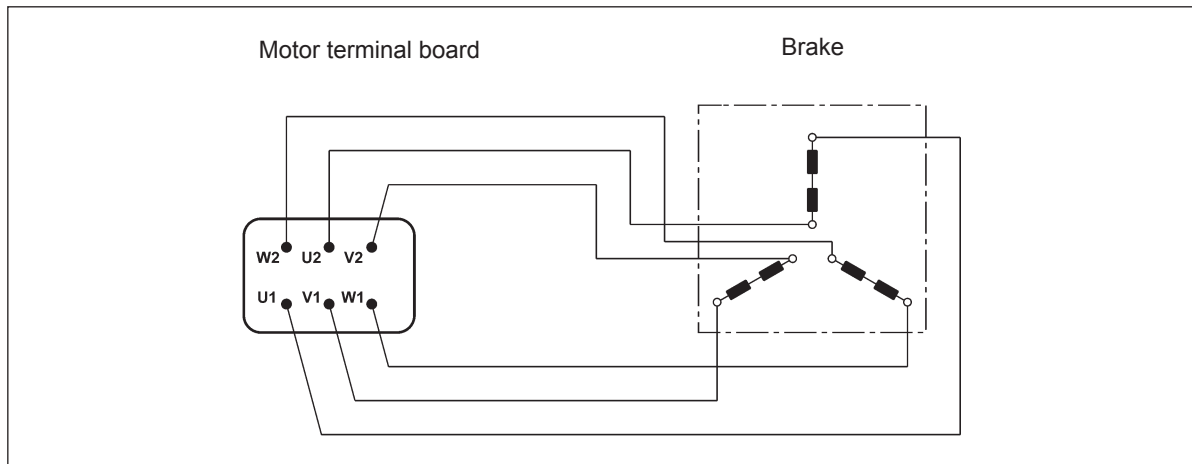

Switch-pole motors and, at request, single-pole motors with separate power supply are equipped with an auxiliary terminal board with 6 terminals for brake connection.

In this version, motors feature a larger terminal box. See diagram below:

(F45)

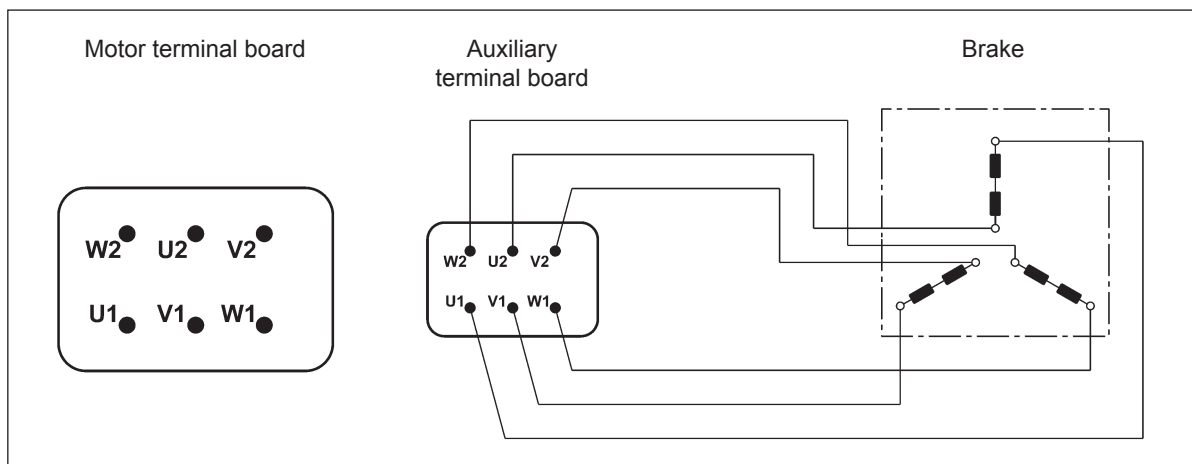

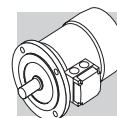

10 BRAKE RELEASE SYSTEMS

Spring-applied brakes type FD and FA may be equipped with optional manual release devices. These are typically used for manually releasing the brake before servicing any machine or plant parts operated by the motor.

R

(F46)

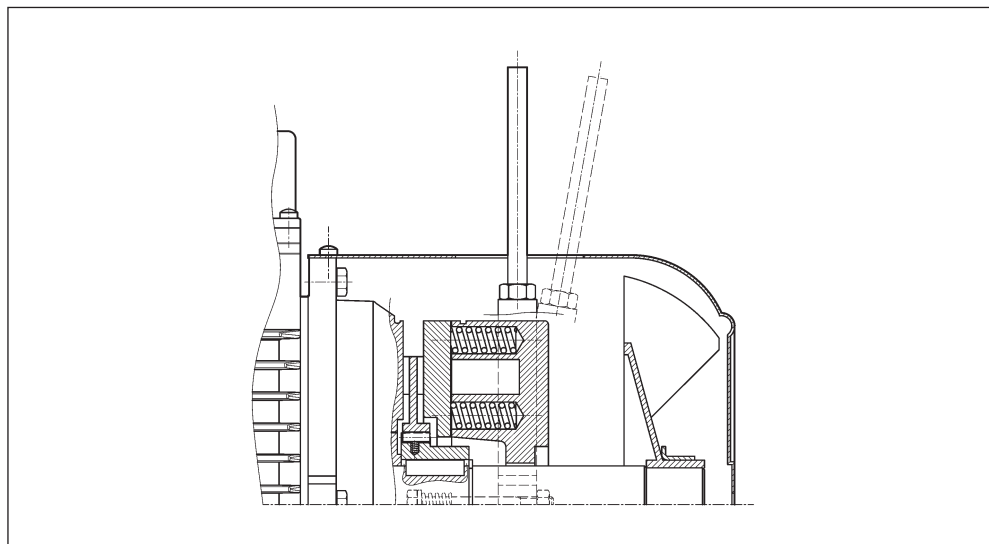

A return spring brings the release lever back in the original position.

RM

(F47)

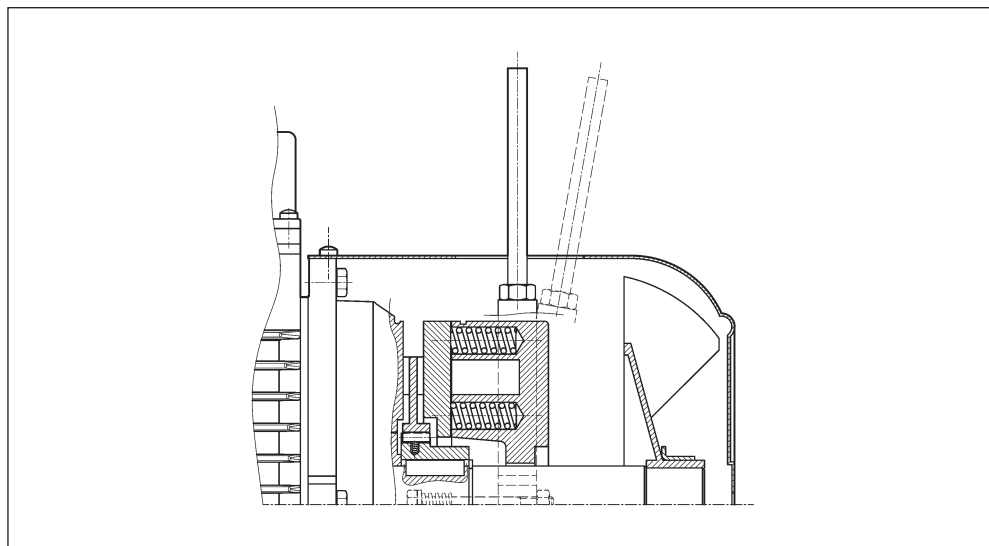

On brake motors type FD, if the option RM is specified, the release device may be locked in the "release" position by tightening the lever until its end becomes engaged with a brake housing projection.

The availability for the various disengagement devices is charted here below:

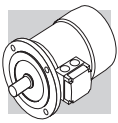

(F48)

	R	RM
BX_FD BN_FD	BX 80...BX 180 BX 200K...BX 315K BN 63...BN 200	BX 80...BX 132 BN 63 ... BN 132 FD07
BX_FA	BX 80...BX 160	-
BN_FA	BN 63...BN 180M	

10,1 Release lever orientation

Unless otherwise specified, the release lever is located 90° away from the terminal box – identified by letters **[AB]** in the diagram below – in a clockwise direction on both options **R** and **RM**. Alternative lever positions **[AA]**, **[AC]** and **[AD]** are also possible when the corresponding option is specified:

(F49)

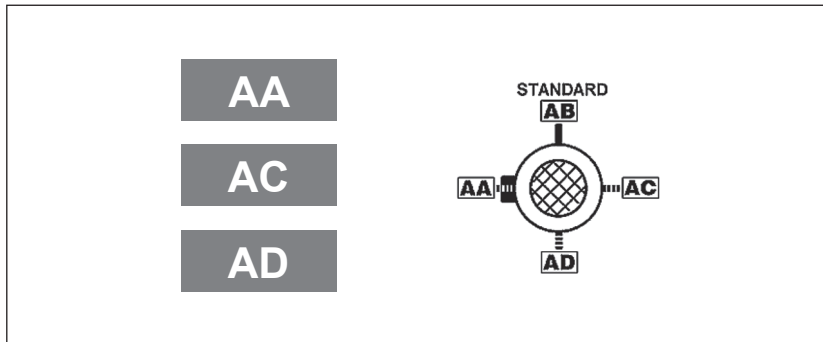

Note: for BX≥200 and BX≥200K AC is not available.

10.2 Separate brake supply

...SA

The brake coil is directly fed through an independent line, separately from the motor. In this case the rated voltage for the coil must be specified, e.g.230SA. The option is applicable to all motors with brake type FD and FA.

Note: for BX≥200 and BX≥200K it is not possible to directly feed the brake from the motor terminal box, it is then necessary to select option SA or SD.

...SD

The brake coil is directly fed with DC current and the rectifier is out of the scope for supply. The rated voltage for the coil must be specified, e.g. 24SD.

Note: for BX≥200 and BX≥200K it is not possible to directly feed the brake from the motor terminal box, it is then necessary to select option SA or SD.

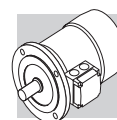

11 OPTIONS

11,1 Soft-start / stop

F1

An optional flywheel - option F1 - is available for applications requiring soft starting or stopping. The flywheel's added inertia uses up kinetic energy during starting and returns it back during braking, thus catering for more progressive and gradual shock loads. The optional flywheel is available for brake motors type BN_FD with specific characteristics as detailed in the table below:

(F50)

Main data for flywheel of motore type: BN_FD		
	Fly-wheel weight [Kg]	Fly-wheel inertia [Kgm ²]
BN 63	0.69	0.00063
BN 71	1.13	0.00135
BN 80	1.67	0.00270
BN 90S - BN 90L	2.51	0.00530
BN 100	3.48	0.00840
BN 112	4.82	0.01483
BN 132S - BN 132M	6.19	0.02580

11,2 Capacitive filter

CF

An optional capacitive filter is available for brake motors type FD only. When the suitable capacitive filter is installed upstream of the rectifier (option CF), motors comply with the emission limits required by standard EN61000-6-3:2007 "Electromagnetic Compatibility – Generic Emission Standard – Part 6-3: Residential, commercial and light industrial environment".

BX \geq 200LA and BX \geq 200LAK motors comply with the emission limits required by standard EN 61000-6-3:2007 "Electromagnetic Compatibility - Generic Emission Standard - Part 6-3: residential, commercial and light industrial environment."

11,3 Thermal protective devices

In addition to the standard protection provided by the magneto-thermal device, motors can be supplied with built-in thermal probes to protect the winding against overheating caused, by insufficient ventilation or by an intermittent duty.

This additional protection should always be specified for servo-ventilated motors (IC416).

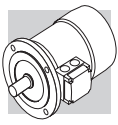

11,4 Thermistors

E3

These are semi-conductors having rapid resistance variation when they are close to the rated switch off temperature (150 °C). Variations of the $R = f(T)$ characteristic are specified under DIN 44081, IEC 34-11 Standards. Positive temperature coefficient thermistors are normally used (also known as PTC “cold conductor resistors”).

Thermistors cannot control relays directly and must be connected to a suitable disconnect device. Thus protected, three PTCs connected in series are installed in the winding, the terminals of which are located on the auxiliary terminal-board.

K1

The design characteristics of this sub-group of PTC thermistors allow them to be used as positive temperature coefficient sensors with variable resistance.

Functioning temperature range: 0°C ... +260°C.

Thermistors cannot control relays directly and must be connected to a suitable disconnect device. Terminals (polarised) for 1 x KTY 84-130 are provided on an auxiliary terminal strip.

11,5 Bimetallic thermostates

D3

These types of protective devices house a bimetal disk. When the rated switch off temperature (150 °C) is reached, the disk switches the contacts from their initial rest position.

As temperature falls, the disk and the contacts automatically return to rest position.

Three bimetallic thermostates connected in series are usually employed, with normally closed contacts. The terminals are located on an auxiliary terminal-board.

11,6 Plug connector

CON

Three types of connectors (CON 1, CON 2, CON 3) are provided; they can be mounted in two different positions: right side of terminal box cover (C1D, C2D, C3D); left side of terminal box cover (C1S, C2S, C3S).

The option CON is applicable to single speed BN motors (2, 4, 6, 8 poles), and BX / BE motors on the sizes specified on the following table. All double speed motors are excluded.

The connectors CON 1 / CON 2 are available for BX, BE and BN motors without brake and for brakemotors equipped with DC brake type FD, for the motor sizes listed below.

The male connector (with pins) is mounted on the motor, the female connector is not provided. With CON option, the winding connection is always Y.

With option U1 “forced ventilation”, the fan unit supply is available inside the separate terminal box fixed to fan cover.

With options EN1...EN6, the encoder connection is made by a cable not connected to the motor plug connector.

The CON option is not applicable to brakemotors equipped with AC brake type FA.

The CON option is not available when at least one of the next options are selected: the U2, CUS, IC.

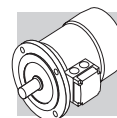

Specifications

(F51)

Option	CON 1
Motor size	BX 80 ... BX 112 / BE 71 ... BE 112 / BN 63 ... BN 112
Connector view	
Type of connector	Harting Han 10ES
Housing	Han EMC 10B with 2 levers
Numbers of pins - nominal current	10 x 16A
Voltage	500 Vac
Contact connection	Screw terminals

(F52)

Option	CON 2
Motor size	BX 80 ... BX 132 / BE 71 ... BE 132M / BN 63 ... BN 160MR
Connector view	
Type of connector	Harting Han Modular
Housing	Han EMC 10B with 2 levers
Module type	Module C + Module E + Module E
Numbers of pins - nominal current	3 x 36A / 6 x 16A
Voltage	500 Vac
Contact connection	Crimping contacts

(F53)

Option	CON 3
Motor size	BX 80 ... BX 132M - BN 63 ... BN 160MR
Connector view	
Type of connector	Harting Han Modular
Housing	Han EMC 10B with 2 levers
Module type	Module C + Module E + Module E
Numbers of pins - nominal current	3 x 36A / 6 + 6 x 16A
Voltage	500 Vac
Contact connection	Crimping contacts

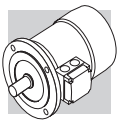

(F54)

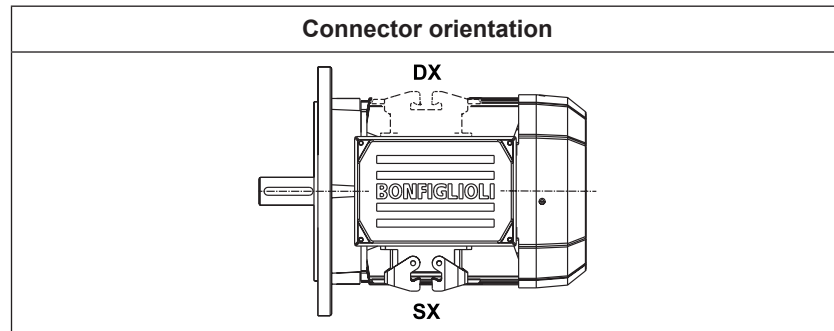

(F55)

Motors without brake dimensions

	AD (mm)	AF (mm)	AH (mm)	LL (mm)	V (mm)
BN 63	136	110	45	165	4.5
BN 71 - BE 71	149	110	45	165	15.5
BX 80 - BE 80 - BN 80	160	110	45	165	16.5
BX 90 - BE 90 - BN 90	162	110	45	165	31.5
BX 100 - BE 100 - BN 100	171	110	45	165	37.5
BX 112 - BE 112 - BN 112	186	110	45	165	39
BX 132 - BE 132 - BN 132	210	140	45	188	45.5
BN 160MR	210	140	45	188	161

(F56)

Motors with FD brake dimensions

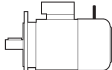
	AD (mm)	AF (mm)	AH (mm)	LL (mm)	V (mm)
BN 63	136	110	45	165	4.5
BN 71	149	110	45	165	1.5
BX 80 - BN 80	160	110	45	165	18.5
BX 90 - BN 90	162	110	45	165	39.5
BX 100 - BN 100	171	110	45	165	63.5
BX 112 - BN 112	186	110	45	165	75
BX 132 - BN 132	210	140	45	188	122
BN 160MR	210	140	45	188	161

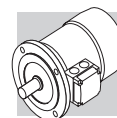

11,7 Control of brake operation

MSW

The microswitch is set in order to obtain from it a signal related to the attraction/release of anchor plate, or it can be set in order to give feedback when the air gap reaches the maximum value.

MSW option is available for all FD brakes.

The microswitch is provided with three lead wires (NC, NO, COM). The next figure shown the main components of the brake equipped with microswitch.

(F57)

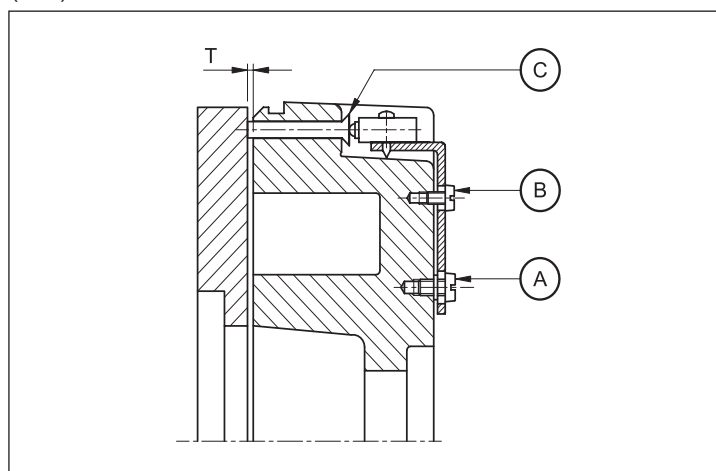

- A: Plate fixing screws
- B: Setting screws
- C: Actuator control pin

11,8 Additional cable entry for brakemotors

IC

The terminal box cover of brakemotors BN 63 ... BN 160MR - BX 80 ... BX 132 is provided with two additional cable entry M16 x 1.5 (one cable entry per side).

The terminal box cover of brakemotors BN 160 ... BN 200 - BX 160 ... BX 180 is provided with an additional cable entry M16 x 1.5 next to the cable entry used for the brake.

11,9 Anti-condensation heaters

H1

NH1

Where an application involves high humidity or extreme temperature fluctuation, motors may be equipped with an anti-condensate heater.

A single-phase power supply is available in the auxiliary terminal board inside the main terminal box. Values for the absorbed power are listed here below:

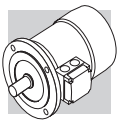

(F58)

	H1	NH1
	1~ 230V ± 10% P [W]	1~ 115V ± 10% P [W]
BX 80 BE 80 BN 56 ... BN 80	10	10
BX 90 ... BX 132 BE 90 ... BE 132MB BN 90 ... BN 160MR	25	25
BX 160...BX 250 BX 160 ... BX 250K BX 160, BX 180 BE 160, BE 180 BN 160, BN 200	50	50
BX 280 BX 280K	60	60
BX 315 ... BX 355 BX 315K ... BX 355K	120	120

Warning! Always remove power supply to the anti-condensate heater before operating the motor.

11.10 Tropicalization

TP

When option **TP** is specified, motor windings receive additional protection for operation in high humidity and temperature conditions.

11.11 Second shaft extension

PS

This option is not compatible with variants RC, TC, U1, U2, EN1, EN2, EN3, EN4, EN5, EN6, EN7, EN8. For shaft dimensions please see motor dimensions tables.

(F59)

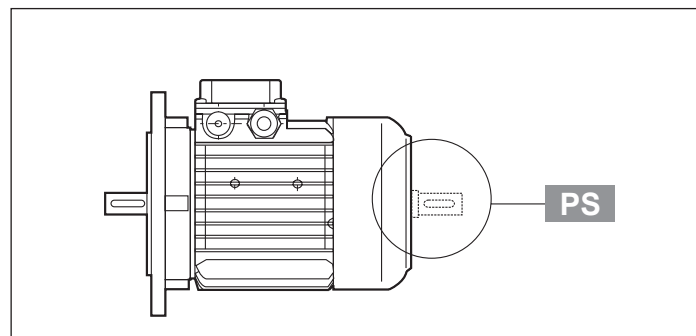

11.12 Rotor balancing

RV

Where low noise is a priority requirement, the option RV ensures reduced vibration in accordance with vibration class B.

The table below reports effective velocity of vibration for normal (A) and B grade balancing.

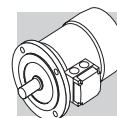

(F60)

Vibration level	Angular velocity n [min ⁻¹]	Limits of the vibration velocity (mm/s) BX 80 ≤ H ≤ BX 335M ≤ BX 355MK BE 80 ≤ H ≤ BE 180L BN 56 ≤ H ≤ BN 200
A	600 < n < 3600	1.6
B	600 < n < 3600	0.70

Values are obtained from measurements on freely suspended motor during no-load operation; tolerance ±10%.

11,13 Ventilation

Motors are cooled through outer air blow (IC 411 according to CEI EN 60034-6) and are equipped with a plastic radial fan, which operates in both directions.

Ensure that fan cover is installed at a suitable distance from the closest wall so to allow air circulation and servicing of motor and brake, if fitted.

On request, motors can be supplied with independently power-supplied forced ventilation system starting from BN 71, BE 80 and BX 80 size.

Motor is cooled by an axial fan with independent power supply and fitted on the fan cover (IC 416 cooling system).

This version is used in case of motor driven by inverter so that steady torque operation is possible even at low speed or when high starting frequencies are needed.

Brake motors of motors with rear shaft projection (PS option) are excluded.

This variant has two different models, called **U1** and **U2**, having the same longitudinal size. Longer side of fan cover (**DL**) is specified for both models in the table below. Overall dimension can be reckoned from motor size table.

(F61)

Extra length for servoventilated motors		
	ΔL_1	ΔL_2
BN 71	93	32
BX 80 - BE 80 - BN 80	127	55
BX 90 - BE 90 - BN 90	131	48
BX 100 - BE 100 - BN 100	119	28
BX 112 - BE 112 - BN 112	130	31
BX 132 - BE 132 - BN 132	161	51
BX 160 - BE 160 - BE 180	184	–
BX 200	260	260
BX 225 - BX 250	320	320
BX 280 - BX 315	430	430
BX 355	640	640

ΔL_1 = extra length to LB value of corresponding standard motor.

ΔL_2 = extra length to LB value of corresponding brake motor.
Only for BN motors.

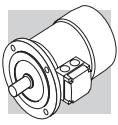

U1

Fan wiring terminals are housed in a separate terminal box.

In brake motors of size BX 132 ... BX 160 - BE 80 ... BE 160 - BN 71 ... BN 160MR, with **U1** model, the release lever cannot be positioned to AA.

This option can be selected for motors compliant with CSA and UL standards (CUS option), only for BX ≥ 200 and BX ≥ 200K.

(F62)

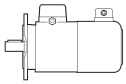
	V a.c. ±10%	Hz	P [W]	I [A]
BN 71	1 ~ 230	50 / 60	22	0.12
BX 80 - BE 80 BN 80			22	0.12
BX 90 - BE 90 BN 90			40	0.30
BX 100 - BE 100 BN 100			50	0.25
BX 112 - BE 112 BN 112	3 ~ 230Δ / 400Y	50	50	0.26 / 0.15
BX 132 - BE 132 BN 132 ... BN 160MR			110	0.38 / 0.22
BX 160 - BE 160 BN 160M ... BN 180M			180	1.25 / 0.72
BX 180 - BE 180 BN 180L ... BN 200L			250	1.51 / 0.87
BX 200 ... BX 250 BX 200K ... BX 250K	3 ~ 400Δ / 690Y	50	250	0.64
BX 280 ... BX 315M BX 280K ... BX 315MK	3 ~ 400Δ / 690Y		750	1.7
BX 315L ... BX 355S BX 315LK ... BX 355SK	3 ~ 400Δ / 690Y		1500	3.3
BX 355M BX 355MK	3 ~ 400Δ / 690Y		3000	6.1

U2

Fan terminals are wired in the motor terminal box.

The **U2** option does not apply to motors BX/BE and to motors with option CUS (compliant to norms CSA and UL).

(F63)

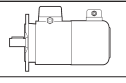
	V a.c. ±10%	Hz	P [W]	I [A]
BN 71	1 ~ 230	50 / 60	22	0.12
BN 80			22	0.12
BN 90			40	0.30
BN 100			40	0.26 / 0.09
BN 112	3 ~ 230Δ / 400Y	50	50	0.26 / 0.15
BN 132 ... BN 160MR			110	0.38 / 0.22

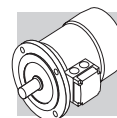

11,14 Rain canopy

RC

The rain canopy protects the motor from dripping and avoids the ingress of solid bodies. It is recommended when motor is installed in a vertical position with the shaft downwards.

Relevant dimensions are indicated in the table below.

The drip cover is not compatible with variants PS, EN1, EN2, EN3, EN4, EN5, EN6.

(F64)

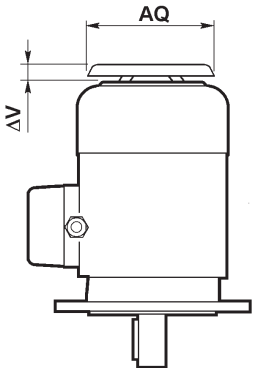
	AQ	ΔV	
BN 63	118	24	
BN 71 - BE 71	134	27	
BX 80 - BE 80 BN 80	152	25	
BX 90 - BE 90 BN 90	168	30	
BX 100 - BE 100 BN 100	190	28	
BX 112 - BE 112 BN 112	211	32	
BX 132 - BE 132 BN 132...BN 160MR	254	32	
BX 160 - BE 160 BN 160M...BN 180M	302	36	
BX 180 - BE 180 BN 180L...BN 200L	340	36	
BX 200	423	55	
BX 225	465	55	
BX 250	514	55	
BX 280	567	100	
BX 315	645	100	
BX 355	740	120	

11,15 Textile canopy

TC

Option TC is a cover variant for textile industry environments, where lint may obstruct the fan grid and prevent a regular flow of cooling air.

This option is not compatible with variants EN1, EN2, EN3, EN4, EN5, EN.

Overall dimensions are the same as drip cover type RC.

TC option is not available for BX motors.

11,16 Feedback units

Motors may be combined with six different types of encoders to achieve feedback circuits.

Configurations with double-extended shaft (PS) and rain canopy (RC, TC) are not compatible with encoder installation.

EN1

Incremental encoder, $V_{IN} = 5 V$, line-driver output RS 422.

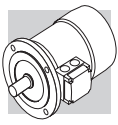

EN2

Incremental encoder, $V_{IN} = 10-30$ V, line-driver output RS 422.

EN3

Incremental encoder, $V_{IN} = 12-30$ V, push-pull output 12-30 V

EN4

Encoder sin/cos, $V_{IN} = 4.5-5.5$ V, output Sinus $0.5V_{PP}$.

EN5

Absolute encoder singleturn, HIPERFACE® interface, $V_{IN} = 7-12$ V.

EN6

Absolute encoder multiturn, HIPERFACE® interface, $V_{IN} = 7-12$ V.

EN7

Incremental encoder Heavy Duty, $V_{IN} = 12-30$ V, push-pull output 12-30 V.

EN8

Incremental encoder Heavy Duty, $V_{IN} = 12-30$ V, push-pull output 9-30 V.

Note: EN7 and EN8 available only for $BX \geq 200$

(F65)

	EN1	EN2	EN3	EN4	EN5	EN6	EN7	EN8	
Interface	TTL/RS 422	TTL/RS 422	HTL push-pull	Sinus 0.5 VPP	HIPERFACE®	HIPERFACE®	HTL push-pull	HTL push-pull	
Power supply voltage [V]	4...6	10...30	12...30	4.4...5.5	7...12	7...12	9...30		
Output voltage [V]	5	5	12...30	—	—	—	9...30		
No-load operating current [mA]	120	100	100	40	80	80	80		
No. of pulses per revolution	1024							2048	
Steps per revolution	—	—	—	—	15 bit	15 bit	-	-	
Revolutions	—	—	—	—	—	12 bit	-	-	
No. of signals	6 (A, B, Z + inverted signals)			6 (cos-, cos+, sin-, sin+, Z, Z)	—	—	6	6	
Max. output frequency [kHz]	600			200			200		
Max. speed [min ⁻¹]	6000 (9000 min ⁻¹ for 10 s)							6000	
Temperature range [°C]	-30 ... +100							-20 ... +85	
Protection class	IP 65							IP67	

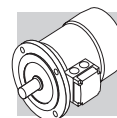

(F66)

EN_ + U1	
	L3
BX 160 - BE 160 - BN 160M...BN 180M	72
BX 160 - BE 180 - BN 180L...BN 200L	82
BX 160_FD - BN 160M_FD...BN 180M_FD	35
BX 180_FD - BN 180L_FD...BN 200L_FD	41
BX 200 - BX 225 - BX 250	100
BX 280 - BX 315 - BX 355	150

(F67)

EN1, EN2, EN3, EN4, EN5, EN6, EN7, EN8	
	L4
BN 63 ... BN 200	65
BE 71... BE180	65
BX 80 ... BX 180	65
BX 200 ... BX 280	100
BX 315 ... BX 355	100

If the encoder device (option EN_) is specified on motors BX 80 ... BX 132 - BE 71 ... BE 132 - BN 71 ... BN 160MR, along with the independent fan cooling (options U1, U2), the extra length of motor is coincident with that of the correspondent U1 and U2 execution.

11.17 Insulated Bearings

IB

NOTE: This option is available for BX and BX K \geq 280, and it is mandatory when the motor is operated through a variable speed drive.

When IB option is selected the motor is equipped with insulated bearings at drive end. This prevents early bearing failures due to high frequency circulation currents.

11.18 Vertical Mounting

VM

NOTE: This option is mandatory for BX \geq 200 and BX \geq 200K, when vertically mounted.

When VM is selected the motor is delivered with specific arrangements.

Furthermore, the vertical mounting position will also be reported on motor nameplate.





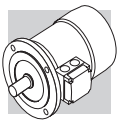

11.19 Surface protection

C_

When no specific protection class is requested, the painted (ferrous) surfaces of motors are protected to at least corrosivity class C2 (UNI EN ISO 12944-2). For improved resistance to atmospheric corrosion, motors can be delivered with C3 and C4 surface protection.



(F68)

	C2	C3	C4	C5M
BN BE BX ≤ 180	standard	 on request	 on request	 Contact us
BX ≥ 200 BX ≥ 200K		standard	 on request	 on request

(F70)

SURFACE PROTECTION	Typical environments	Maximum surface temperature	Corrosivity class according to UNI EN ISO 12944-2
C3	Urban and industrial environments with up to 100% relative humidity (medium air pollution)	120°C	C3
C4	Industrial areas, coastal areas, chemical plant, with up to 100% relative humidity (high air pollution)	120°C	C4
C5M	Coast and offshore areas with high salt content.	120°C	C5M

Motors with optional protection to class C3 or C4 are available in a choice of colours. If no specific colour is requested (see the “PAINTING” option) motors are finished in RAL 7042 for BN, BE and BX≤180 and in Munsell blue 8B 4.5/3.25 for BX≥200.

Motors can also be supplied with surface protection for corrosivity class C5 according to UNI EN ISO 12944-2. Contact our Technical Service for further details.

11.20 Painting

RAL

Motors with optional protection to class C3 or C4 are available in the colours listed in the following table.

(F69)

PAINTING	Colour	RAL number
RAL7042	Traffic Grey A	7042
RAL5010	Gentian Blue	5010
RAL9005	Jet Black	9005
RAL9006	White Aluminium	9006
RAL9010	Pure White	9010
Munsell blue 8B* 4.5/3.25	Blue	MUNSELL 8B 4.5/3.25

* BX ≥ 200 and BX ≥ 200K Motors are standardly supplied in this colour with C3 protection unless specified differently.

NOTE – “PAINTING” options can only be specified in conjunction with “SURFACE PROTECTION” options.

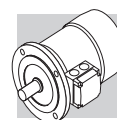

11.21 Certificates

ACM

Certificate of compliance of motors

The document certifies the compliance of the product with the purchase order and the construction in conformity with the applicable procedures of the Bonfiglioli Quality System.

Note: Not available for BX \geq 200 and BX \geq 200K

CC

Inspection certificate

The document entails checking on order compliance, the visual inspection of external conditions and instrumental testing of the electrical characteristics in unloaded conditions. Units inspected are sampled within the shipping batch and marked individually.

12 TABLES OF MOTORS CORRELATION

12.1 50 Hz Motors

(F71)

pole	2			
	IE1	IE2	IE3	
Pn [kW]	0.06			
	0.09			
	0.12			
	0.18	BN 63A 2		
	0.25	BN 63B 2		
	0.37	BN 71A 2		
	0.55	BN 71B 2		
	0.75	BN 71C 2	BE 80A 2	
		BN 80A 2		
	1.1	BN 80B 2	BE 80B 2	
	1.5	BN 90SA 2	BE 90SA 2	
	1.85	BN 90SB 2		
	2.2	BN 90L 2	BE 90L 2	
	3	BN 100L 2	BE 100L 2	
	4	BN 112M 2	BE 112M 2	
	5.5	BN 132SA 2	BE 132SA 2	
	7.5	BN 132SB 2	BE 132SB 2	
	9.2	BN 132M 2	BE 132MB 2	
	11	BN 160MR 2	BE 160MA 2	
		BN 160M 2		
15	BN 160MB 2	BE 160MB 2		
18.5	BN 160L 2	BE 160L 2		
22	BN 180M 2			
30	BN 200LA 2			

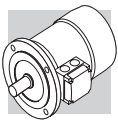

(F72)

pole	4			
	Efficiency class	IE1	IE2	IE3
Pn [kW]	0.06	BN 56A 4		
	0.09	BN 56B 4		
	0.12	BN 63A 4		
	0.18	BN 63B 4		
	0.25	BN 63C 4		
		BN 71A 4		
	0.37	BN 71B 4		
	0.55	BN 71C 4		
		BN 80A 4		
	0.75	BN 80B 4	BE 80B 4	BX 80B 4
	1.1	BN 80C 4	BE 90S 4	BX 90S 4
		BN 90S 4		
	1.5	BN 90LA 4	BE 90LA 4	BX 90LA 4
	1.85	BN 90LB 4		
	2.2	BN 100LA 4	BE 100LA 4	BX 100LA 4
	3	BN 100LB 4	BE 100LB 4	BX 100LB 4
	4	BN 112M 4	BE 112M 4	BX 112M 4
	5.5	BN 132S 4	BE 132S 4	BX 132SB 4
	7.5	BN 132MA 4	BE 132MA 4	BX 132MA 4
	9.2	BN 132MB 4	BE 132MB 4	BX 160MA 4
	11	BN 160MR 4	BE 160M 4	BX 160MB 4
		BN 160M 4		
	15	BN 160L 4	BE 160L 4	BX 160L 4
	18.5	BN 180M 4	BE 180M 4	BX 180M 4
	22	BN 180L 4	BE 180L 4	BX 180L 4
	30	BN 200L 4		BX 200LA 4*
	37			BX 225SA 4*
	45			BX 225SB 4*
	55			BX 250MA 4*
	75			BX 280SA 4*
	90			BX 280SB 4*
	110			BX 315SA 4*
132			BX 315SB 4*	
160			BX 315SC 4*	
200			BX 315MA 4*	
250			BX 355MA 4*	
315			BX 355MB 4*	
355			BX 355MC 4*	

Note: For the Australian market these motor has to be selected in the BX ... K 4 Version

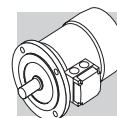

(F73)

pole		6		
Efficiency class		IE1	IE2	IE3
Pn [kW]	0.06			
	0.09	BN 63A 6		
	0.12	BN 63B 6		
	0.18	BN 71A 6		
	0.25	BN 71B 6		
		BN 71C 6		
	0.37	BN 80A 6		
	0.55	BN 80B 6		
	0.75	BN 80C 6	BE 90S 6	
		BN 90S 6		
	1.1	BN 90L 6	BE 100M 6	
	1.5	BN 100LA 6	BE 100LA 6	
	1.85	BN 100LB 6		
	2.2	BN 112M 6	BE 112M 6	
	3	BN 132S 6	BE 132S 6	
	4	BN 132MA 6	BE 132MA 6	
	5.5	BN 132MB 6	BE 160MA 6	
	7.5	BN 160M 6	BE 160MB 6	
	9.2			
	11	BN 160L 6		
15	BN 180L 6			
18.5	BN 200LA 6			
22				
30				

12.2 60 Hz Motors

(F74)

pole		2		
Efficiency class		IE1	IE2	IE3
Pn [kW]	0.06			
	0.09			
	0.12			
	0.18	BN 63A 2		
	0.25	BN 63B 2		
	0.37	BN 71A 2		
	0.55	BN 71B 2		
	0.75	BN 71C 2		
		BN 80A 2		
	1.1	BN 80B 2		
	1.5	BN 90SA 2		
	1.85	BN 90SB 2		
	2.2	BN 90L 2		
	3	BN 100L 2		
	3.7	BN 112M 2		
	5.5	BN 132SA 2		
	7.5	BN 132SB 2		
	9.2	BN 132M 2		
	11	BN 160MR 2		
		BN 160M 2		
15	BN 160MB 2			
18.5	BN 160L 2			
22	BN 180M 2			
30	BN 200LA 2			

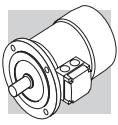

(F75)

pole	4			
	Efficiency class	IE1	IE2	IE3
Pn [kW]	0.06	BN 56A 4		
	0.09	BN 56B 4		
	0.12	BN 63A 4		
	0.18	BN 63B 4		
	0.25	BN 63C 4		
		BN 71A 4		
	0.37	BN 71B 4		
	0.55	BN 71C 4		
		BN 80A 4		
	0.75	BN 80B 4	BE 80B 4	BX 90SR 4
	1.1	BN 80C 4	BE 90S 4	BX 90S 4
		BN 90S 4		
	1.5	BN 90LA 4	BE 90LA 4	BX 90LA 4
	1.85	BN 90LB 4		
	2.2	BN 100LA 4	BE 100LA 4	BX 100LA 4
	3	BN 100LB 4	BE 100LB 4	BX 100LB 4
	3.7	BN 112M 4	BE 112M 4	BX 112M 4
	5.5	BN 132S 4	BE 132S 4	BX 132SB 4
	7.5	BN 132MA 4	BE 132MA 4	BX 132MA 4
	9.2	BN 132MB 4	BE 132MB 4	BX 160MA 4
	11	BN 160MR 4	BE 160M 4	BX 160MB 4
		BN 160M 4		
	15	BN 160L 4	BE 160L 4	BX 160L 4
	18.5	BN 180M 4	BE 180M 4	BX 180M 4
	22	BN 180L 4	BE 180L 4	BX 180L 4
	30	BN 200L 4		BX 200LAK 4
	37			BX 225SAK 4
	45			BX 225SBK 4
	55			BX 280SAK 4
	75			BX 280SBK 4
	90			BX 315SAK 4
	110			BX 315SBK 4
	132			BX 315SCK 4
160			BX 355SAK 4	
200			BX 355SBK 4	
250			BX 355SCK 4	
315			BX 355MBK 4	
355			BX 355MCK 4	

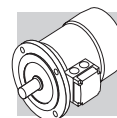

(F76)

pole		6		
Efficiency class		IE1	IE2	IE3
Pn [kW]	0.06			
	0.09	BN 63A 6		
	0.12	BN 63B 6		
	0.18	BN 71A 6		
	0.25	BN 71B 6		
		BN 71C 6		
	0.37	BN 80A 6		
	0.55	BN 80B 6		
	0.75	BN 80C 6		
		BN 90S 6		
	1.1	BN 90L 6		
	1.5	BN 100LA 6		
	1.85	BN 100LB 6		
	2.2	BN 112M 6		
	3	BN 132S 6		
	3.7	BN 132MA 6		
	5.5	BN 132MB 6		
	7.5	BN 160M 6		
	9.2			
	11	BN 160L 6		
15	BN 180L 6			
18.5	BN 200LA 6			
22				
30				

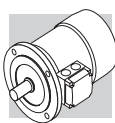

13 MOTOR RATING CHARTS BX

4 P		1500 min ⁻¹ - S1															50 Hz - IE3					
		d.c. brake															a.c. brake					
P _n kW	CE	n	M _n Nm	I _n 400V A	η%			cos φ	I _s I _n	M _s M _n	M _a M _n	KVA code	J _m x 10 ⁻⁴ kgm ²	IM B5 Kg	Mod	M _b Nm	J _m x 10 ⁻⁴ kgm ²	IM B5 Kg	Mod	M _b Nm	J _m x 10 ⁻⁴ kgm ²	IM B5 Kg
					100%	75%	50%															
0.75		BX 80B 4	5.0	1.61	82.5	83.9	83.2	0.81	6.5	2.0	1.8	J	35	16	FD 04	15	37	19.9	FA 04	15	37	19.8
1.1		BX 90S 4	7.4	2.44	84.1	84.1	82.0	0.77	6.9	3.4	2.2	J	27	16	FD 14	15	29	20.2	FA 14	15	29	20.1
1.5		BX 90LA 4	10.1	3.3	85.3	86.2	84.9	0.78	6.3	3.1	1.9	J	31	17	FD 05	26	35	23	FA 05	26	35	23.7
2.2		BX 100LA 4	14.5	5.1	86.7	86.2	84.0	0.72	7.2	3.6	2.4	K	58	24	FD 15	40	62	31	FA 15	40	62	31
3		BX 100LB 4	19.8	6.7	87.7	87.7	86.0	0.74	7.6	3.9	2.6	K	73	29	FD 15	40	77	36	FA 15	40	77	36
4		BX 112M 4	26	8.1	88.6	88.9	87.6	0.8	8.1	3.8	2.5	J	130	38	FD 06S	60	139	48	FA 06S	60	139	50
5.5		BX 132SB 4	36	10.6	89.6	89.2	88.8	0.83	8.2	3.6	2.3	J	310	57	FD 56	75	320	70	FA 06	75	320	71
7.5		BX 132MA 4	49	15.0	90.4	90.9	90.2	0.80	8.4	3.8	2.5	K	360	67	FD 06	100	370	80	FA 07	100	370	85
9.2		BX 160MA 4	60	17.8	91.0	92.1	91.7	0.82	7.9	3.6	2.1	J	650	95	FD 08	170	725	125	FA 08	170	725	124
11		BX 160MB 4	72	20.5	91.4	92.9	92.5	0.84	7.8	3.4	1.9	J	780	110	FD 08	170	855	140	FA 08	170	855	139
15		BX 160L 4	98	28.1	92.1	93.2	92.6	0.82	9.0	4.1	2.3	K	890	121	FD 08	200	965	151	FA 08	200	965	150
18.5		BX 180M 4	119	32.9	92.6	94.1	93.1	0.85	11.3	2.6	2.3	M	1560	155	FD 09	300	1760	195				
22		BX 180L 4	142	38.2	93.0	93.6	92.8	0.88	10.2	2.5	2.0	L	1660	163	FD 09	300	1860	203				

Note: for more details on the available energy certifications look at the catalog's dedicated section.

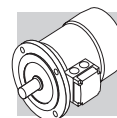

4 P		1500 min ⁻¹ - S1											50 Hz - IE3											
P _n kW	CE	CCC	n min ⁻¹	In 400V A	M _n Nm	η%	cos ψ	I _s I _n	M _s M _n	M _a M _n	KVA code	J _m x 10 ⁻⁴ kgm ²	IM B5 Kg	d.c. brake			a.c. brake							
														100%	75%	50%	Mod	M _b Nm	J _m x 10 ⁻⁴ kgm ²	IM B5 Kg	Mod	M _b Nm	J _m x 10 ⁻⁴ kgm ²	IM B5 Kg
30			BX 200LA 4	1483	193.2	93.6	0.84	7.5	2.7	3.2	N/A	3850	292	FD20	260	3910	317							
37			BX 225SA 4	1482	238.6	93.9	0.83	7.2	3.1	3.1	N/A	4270	322	FD25	400	4450	356							
45			BX 225SB 4	1482	290	94.2	0.84	8	3.2	3.5	N/A	5250	357	FD25	400	5430	391							
55			BX 250MA 4	1482	354.2	94.6	0.84	7.1	2.9	3.4	N/A	6940	406	FD30	1000	7540	452							
75			BX 280SA 4	1485	483	95	0.86	6.4	2.3	2.8	N/A	13800	645	FD30	1000	14400	691							
90			BX 280SB 4	1485	578	95.2	0.86	7.1	2.5	2.9	N/A	17300	700	FD30	1000	17900	746							
110			BX 315SA 4	1489	705	95.4	0.84	7	2.1	3	N/A	24300	930	FD30	1000	24900	976							
132			BX 315SB 4	1488	847	95.6	0.86	6.7	2.2	2.9	N/A	29000	1000	FD160	1600	30500	1121							
160			BX 315SC 4	1488	1026	95.8	0.85	6.9	2.2	3	N/A	32000	1065	FD160	1600	33500	1186							
200			BX 315MA 4	1487	1284	96	0.86	6.8	2.4	3	N/A	39000	1220	FD250	2500	41400	1390							
250			BX 355MA 4	1491	1601	96	0.86	6.4	2.1	2.9	N/A	59000	1610	FD250	2500	61400	1780							
315			BX 355MB 4	1491	2018	96	0.85	7.3	2.4	3.3	N/A	69000	1780	FD400	4000	73300	2000							
355			BX 355MC 4	1490	2273	96	0.86	6.3	2.3	2.8	N/A	72000	1820	FD400	4000	76300	2040							

Note: for more details on the available energy certifications look at the catalog's dedicated section.

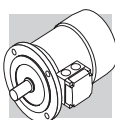





4 P		1500 min ⁻¹ - S1											50 Hz - IE3									
P _n kW			n min ⁻¹	M _n Nm	I _n 400V A	η%		cos ψ	$\frac{I_s}{I_h}$	$\frac{M_s}{M_n}$	$\frac{M_a}{M_n}$	KVA code	J _m x 10 ⁻⁴ kgm ²	IM B5 	d.c. brake				a.c. brake			
						100%	75%								FD		FA					
						100%	75%								Mod	M _b Nm	J _m x 10 ⁻⁴ kgm ²	IM B5 	Mod	M _b Nm	J _m x 10 ⁻⁴ kgm ²	IM B5
30	BX 200LAK 4	1483	193	55.7	94.7	95.1	0.82	8.3	3	3.3	N/A	3660	319	FD 8	400	3940	337					
37	BX 225SAK 4	1482	238	65.9	95.1	95.5	0.85	7.7	2.8	3.1	N/A	5360	398	FD 9	600	5720	426					
45	BX 225SBK 4	1481	290	80.4	95.2	95.6	0.85	7.9	2.8	3.2	N/A	5360	398	FD 9	600	5720	426					
55	BX 250MAK 4	1485	354	98.9	95.6	95.8	0.84	7.9	3	3.3	N/A	9330	476	FD 10	800	10080	521					
75	BX 280SAK 4	1487	482	134	95.9	96.2	0.84	7.3	2.5	2.8	N/A	15000	665	FD 1000	1000	15360	771					
90	BX 280SBK 4	1487	578	161	96.2	96.4	0.84	7.9	2.9	3	N/A	18500	725	FD 1000	1000	18860	831					
110	BX 315SAK 4	1491	704	194	96.8	97	0.84	8.3	2.4	3.1	N/A	29000	1000	FD 1000	1000	29360	1106					
132	BX 315SBK 4	1490	846	234	96.9	97.1	0.84	8.1	2.6	3.2	N/A	32000	1065	FD 1600	1600	32500	1233					
160	BX 315SCK 4	1490	1025	279	96.7	96.9	0.86	8.2	2.7	3	N/A	39000	1220	FD 1600	1600	39500	1388					
200	BX 355SAK 4	1491	1281	345	96.6	96.7	0.87	7.3	2.1	2.7	N/A	59000	1610	FD 2500	2500	59500	1778					
250	BX 355MAK 4	1491	1601	435	96	96	0.86	6.4	2.1	2.9	N/A	69000	1780	FD 2500	2500	69500	1948					
315	BX 355MBK 4	1491	2017	550	96	96.1	0.85	7.3	2.4	3.3	N/A	72000	1820	FD 2500	2500	72500	1988					
355	BX 355MCK 4	1490	2275	616	96	96.2	0.86	6.3	2.3	2.8	N/A	84000	2140	FD 2500	2500	84500	2308					

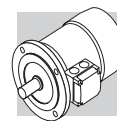

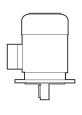
Note: for more details on the available energy certifications look at the catalog's dedicated section.



4 P		1800 min ⁻¹ - S1											60 Hz - Nema Premium								
P _n kW	 n min ⁻¹	M _n Nm	I _n 400V A	η%			cos φ	I _s I _n	M _s M _n	M _a M _n	KVA code	J _m x 10 ⁻⁴ kgm ²	IM B5 	d.c. brake				a.c. brake			
				100%	75%	50%								FD				FA			
				Mod	M _b Nm	J _m x 10 ⁻⁴ kgm ²								IM B5 	Mod	M _b Nm	J _m x 10 ⁻⁴ kgm ²	IM B5 	Mod	M _b Nm	J _m x 10 ⁻⁴ kgm ²
0.75	BX 90SR 4	4.1	1.48	85.5	86.4	83.9	0.73	8.0	3.7	2.5	L	27	16	FD 14	15	29	20.2	FA 14	15	29	20.1
1.1	BX 90S 4	6.0	2.15	86.5	85.9	83.0	0.74	8.2	4.1	2.8	K	27	16	FD 14	15	29	20.2	FA 14	15	29	20.1
1.5	BX 90LA 4	8.3	2.91	86.5	86.5	84.4	0.75	7.4	3.6	2.5	K	31	17	FD 05	26	35	23	FA 05	26	35	23.7
2.2	BX 100LA 4	11.9	4.4	89.5	88.6	86.2	0.71	9.9	4.8	3.6	N	73	29	FD 15	40	77	36	FA 15	40	77	36
3	BX 100LB 4	16.4	5.9	89.5	88.9	86.7	0.71	9.1	4.4	3.3	M	73	29	FD 15	40	77	36	FA 15	40	77	36
3.7	BX 112M 4	20	6.7	89.5	89.5	89.1	0.77	10.4	4.7	3.4	M	130	38	FD 06S	60	139	48	FA 06S	60	139	50
5.5	BX 132SB 4	30	9.9	91.7	92.0	90.2	0.76	10.7	5.1	4.6	N	410	77	FD 56	75	420	90	FA 06	75	420	91
7.5	BX 132MA 4	41	13.4	91.7	91.3	89.7	0.76	11.0	4.9	4.4	N	410	77	FD 06	100	420	90	FA 07	100	420	95
9.2	BX 160MA 4	50	15.6	92.4	92.5	91.6	0.8	9.1	4.1	2.6	L	650	95	FD 08	170	725	125	FA 08	170	725	124
11	BX 160MB 4	59	18.2	92.4	92.9	92.0	0.82	9.3	4.0	2.4	L	780	110	FD 08	170	855	140	FA 08	170	855	139
15	BX 160L 4	81	24.5	93.0	93.5	92.5	0.81	10.9	4.8	2.8	M	890	121	FD 08	200	965	151	FA 08	200	965	150
18.5	BX 180M 4	99	28.6	93.6	94.5	93.2	0.85	13.0	2.9	2.7	N	1560	155	FD 09	300	1760	195				
22	BX 180L 4	118	33.1	93.6	94.2	93.1	0.87	11.5	2.8	2.4	M	1660	163	FD 09	300	1860	203				

Note: for more details on the available energy certifications look at the catalog's dedicated section.

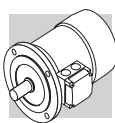

4 P		1800 min ⁻¹ - S1											60 Hz - Nema Premium									
P _n	kWh	UL CERTIFIED E473868 SAFETY US CI PROCEL NBR - 17094-1/2008	n min ⁻¹	M _n Nm	I _n 400V A	η%		cos ψ	I _s I _n	M _s M _n	M _a M _n	KVA code	J _m x 10 ⁻⁴ kgm ²	IM B5 Kg	d.c. brake			a.c. brake				
						100%	75%								50%	Mod	M _b Nm	J _m x 10 ⁻⁴ kgm ²	IM B5 Kg	Mod	M _b Nm	J _m x 10 ⁻⁴ kgm ²
30	BX 200LAK 4	1786	160	47.9	100%	94.7	94.8	0.83	9.4	3.3	3.7	N/A	3660	319	FD 8	400	3940	337	FD 8	400	3940	337
37	BX 225SAK 4	1784	198	57.3	95.3	95.3	94.9	0.85	8.8	2.9	3.4	N/A	5360	398	FD 9	600	5720	426	FD 9	600	5720	426
45	BX 225SBK 4	1785	240	70.5	95.3	95.3	94.8	0.84	8.9	3	3.6	N/A	5360	398	FD 9	600	5720	426	FD 9	600	5720	426
55	BX 250MAK 4	1787	293	85.8	95.7	95.7	95.2	0.84	9.1	3.3	3.7	N/A	9330	476	FD 10	800	10080	521	FD 10	800	10080	521
75	BX 280SAK 4	1788	401	117	95.9	95.9	94.7	0.84	8.4	2.7	3.1	N/A	15000	665	FD 1000	1000	15360	771	FD 1000	1000	15360	771
90	BX 280SBK 4	1788	481	140	96.1	96.1	95	0.84	9	3.1	3.3	N/A	18500	725	FD 1000	1000	18860	831	FD 1000	1000	18860	831
110	BX 315SAK 4	1792	586	172	96.1	96.1	96	0.84	8.8	2.6	3.4	N/A	29000	1000	FD 1000	1000	29360	1106	FD 1000	1000	29360	1106
132	BX 315SBK 4	1791	704	206	96.4	96.4	95.6	0.84	9	2.8	3.6	N/A	32000	1065	FD 1600	1600	32500	1233	FD 1600	1600	32500	1233
160	BX 315SCK 4	1791	853	241	96.4	96.4	95.9	0.86	9	2.9	3.3	N/A	39000	1220	FD 1600	1600	39500	1388	FD 1600	1600	39500	1388
200	BX 355SAK 4	1792	1065	301	96.4	96.4	96.2	0.87	8.3	2.2	3	N/A	59000	1610	FD 2500	2500	59500	1778	FD 2500	2500	59500	1778
250	BX 355MAK 4	1792	1332	381	96.7	96.7	96.6	0.86	8.8	2.7	3.2	N/A	69000	1780	FD 2500	2500	69500	1948	FD 2500	2500	69500	1948
315	BX 355MBK 4	1791	1679	479	96.7	96.7	96.6	0.85	8.5	3.1	3.2	N/A	72000	1820	FD 2500	2500	72500	1988	FD 2500	2500	72500	1988
355	BX 355MCK 4	1792	1893	541	96.7	96.7	96.5	0.86	7.2	2.4	3.1	N/A	84000	2140	FD 2500	2500	84500	2308	FD 2500	2500	84500	2308



Note: for more details on the available energy certifications look at the catalog's dedicated section.

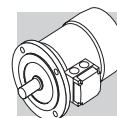

14 MOTORS DIMENSIONS BX

BX - IM B3

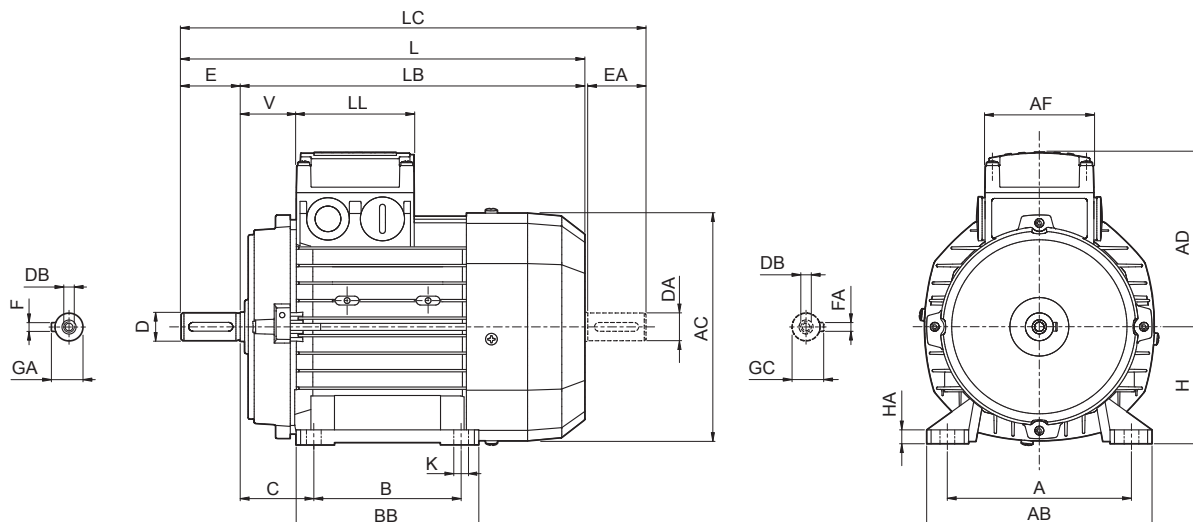

BX

	Shaft					Housing						Motor																			
	D DA	E EA	DB	GA GC	F FA	B	A	HA	BB	AB	K	C	H	AC	L	LB	LC	AD	AF	LL	V										
BX 80 B	19 14 ⁽¹⁾	40 30 ⁽¹⁾	M6 M5 ⁽¹⁾	21.5 16 ⁽¹⁾	6 5 ⁽¹⁾	100	125	8	124	153	10	50	80	156	320	280	351	119	74	80	38										
BX 90 S	24 19 ⁽¹⁾	50 40 ⁽¹⁾	M8 M6 ⁽¹⁾	27 21.5 ⁽¹⁾	8 6 ⁽¹⁾		140		174	155		174	10	56	90	176	326	276	368 378	133	98	98	44								
BX 90 LA						125																									
BX 100 LA	28 24 ⁽¹⁾	60 50 ⁽¹⁾	M10 M8 ⁽¹⁾	31 27 ⁽¹⁾	8 8 ⁽¹⁾	140	160	10	175	192	12	63	100	195	410	350	462	142	98	98	50										
BX 100 LB							190			224		70	112	219	430	370	482	157			52										
BX 112 M																															
BX 132 SB	38 28 ⁽¹⁾	80 60 ⁽¹⁾	M12 M10 ⁽¹⁾	41 31 ⁽¹⁾	10 8 ⁽¹⁾	140	216	12	218	254	12	89	132	258	493	413	556	193	118	118	58										
BX 132 MA						178									528	448	591														
BX 160 MA	42 38 ⁽¹⁾	110 80 ⁽¹⁾	M16 M12 ⁽¹⁾	45 41 ⁽¹⁾	12 10 ⁽¹⁾	210	254	25	304	319	14.5	108	160	310	596	486	680	245	187	187	51										
BX 160 MB						254									304	319	14.5				108	160	310	640	530	724	51				
BX 160 L																															
BX 180 M	48 42 ⁽¹⁾	110 110 ⁽¹⁾	M16 M16 ⁽¹⁾	51.5 45 ⁽¹⁾	14 12 ⁽¹⁾	241	279	26	291	359	14	121	180	348	708	598	823	261	187	187	52										
BX 180 L						279									329	359	14	121			180	348	708	598	823	261					
BX 200LA	55 45 ⁽¹⁾	140 110 ⁽¹⁾	M20 M20 ⁽¹⁾	59 48.5 ⁽¹⁾	16 14 ⁽¹⁾	267	318	23	345	378	18,5	133	200	417	821	711	934	328	300	311	48										
BX 225SA	60 55 ⁽¹⁾			64 59 ⁽¹⁾	18 16 ⁽¹⁾	286	356		351	435		149	225	460	879	739	1001	348													
BX 225SB																															
BX 250MA	65 55 ⁽¹⁾	140 140 ⁽¹⁾	M20 M20 ⁽¹⁾	69 59 ⁽¹⁾	18 16 ⁽¹⁾	311	406	31	392	480	24	168	250	510	884	744	1010	376	434	306	43										
BX 280SA	75 65 ⁽¹⁾			79.5 69 ⁽¹⁾	20 18 ⁽¹⁾	368	457		506	530		190	280	564	1088	948	1238	482													
BX 280SB																															
BX 315SA	80 75 ⁽¹⁾	170 140 ⁽¹⁾	M24 M20 ⁽¹⁾	85 79.5 ⁽¹⁾	22 20 ⁽¹⁾	406	508	40	558	590	28	216	315	639	1204	1034	1352	537	473	347	42										
BX 315SB																															
BX 315SC																															
BX 315MA	90 75 ⁽¹⁾			95 79.5 ⁽¹⁾	25 20 ⁽¹⁾	457			669						1315	1145	1463														
BX 355MA	100 75 ⁽¹⁾	210 170 ⁽¹⁾	M24 M20 ⁽¹⁾	106 79.5 ⁽¹⁾	28 20 ⁽¹⁾	500	610	45	722	700	35	254	355	725	1479	1269	1659	603	694	413	50										
BX 355MB																															
BX 355MC																															

N.B.: 1) These values refer to the rear shaft end (PS).

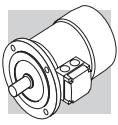

BX - IM B5

BX

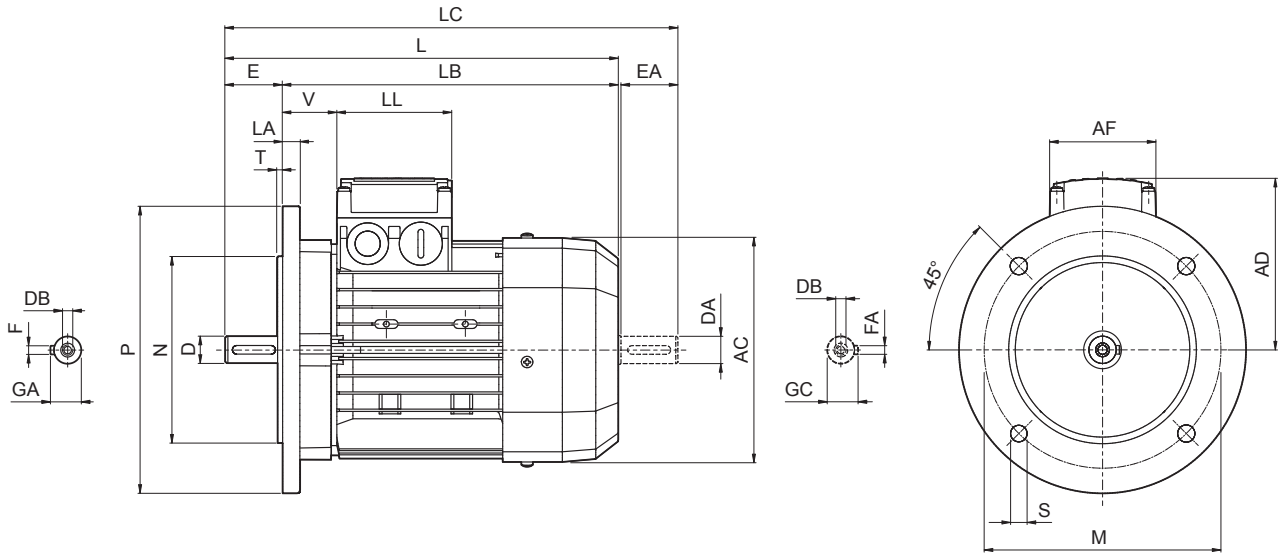

	Shaft					Flange					Motor								
	D DA	E EA	DB	GA GC	F FA	M	N	P	S	T	LA	AC	L	LB	LC	AD	AF	LL	V
BX 80 B	19 14 ⁽¹⁾	40 30 ⁽¹⁾	M6 M5 ⁽¹⁾	21.5 16 ⁽¹⁾	6 5 ⁽¹⁾	165	130	200	11.5	3.5	11.5	156	320	280	351	119	74	80	38
BX 90 S	24 19 ⁽¹⁾	50 40 ⁽¹⁾	M8 M6 ⁽¹⁾	27 21.5 ⁽¹⁾	8 6 ⁽¹⁾							176	326	276	368	133	98	98	44
BX 90 LA																			
BX 100 LA	28 24 ⁽¹⁾	60 50 ⁽¹⁾	M10 M8 ⁽¹⁾	31 27 ⁽¹⁾	8 8 ⁽¹⁾	215	180	250	14	4	14	195	410	350	462	142	98	98	50
BX 100 LB											15	219	430	370	482	157			52
BX 112 M											20	258	493	413	556	193	118	118	58
BX 132 SB	38 28 ⁽¹⁾	80 60 ⁽¹⁾	M12 M10 ⁽¹⁾	41 31 ⁽¹⁾	10 8 ⁽¹⁾	265	230	300	20	258	528	448	591	187	187	51	52		
BX 132 MA											596	486	680					245	
BX 160 MA	42 38 ⁽¹⁾	110 80 ⁽¹⁾	M16 M12 ⁽¹⁾	45 41 ⁽¹⁾	12 10 ⁽¹⁾	300	250	350	18.5	15	310	640	530	724	261	187	187	51	
BX 160 MB											596	486	680	245					
BX 160 L											18	348	708	598	823	261	187	187	52
BX 180 M	48 42 ⁽¹⁾	110 110 ⁽¹⁾	M16 M16 ⁽¹⁾	51.5 45 ⁽¹⁾	14 12 ⁽¹⁾	350	300	400	5	20	423	821	711	934	328	300			311
BX 180 L											465	879	739	1001	348				
BX 200LA	55 45 ⁽¹⁾	140 110 ⁽¹⁾	M20 M20 ⁽¹⁾	59 48.5 ⁽¹⁾	16 14 ⁽¹⁾	500	450	550	18	23	514	884	744	1010	376	434	306	43	
BX 225SA	60 55 ⁽¹⁾			64 59 ⁽¹⁾	18 16 ⁽¹⁾						400	350	450	19	423				821
BX 225SB											567	1088	948	1238	482	434	306	43	
BX 250MA	65 55 ⁽¹⁾			69 59 ⁽¹⁾							645	1204	1034	1352	537	473	347	42	
BX 280SA	75 65 ⁽¹⁾	140 140 ⁽¹⁾	M20 M20 ⁽¹⁾	79.5 69 ⁽¹⁾	20 18 ⁽¹⁾	600	550	660	23	6	25	1315	1145	1463	603	694	413	50	
BX 280SB				79.5 69 ⁽¹⁾	20 18 ⁽¹⁾							400	350	450					19
BX 315SA	80 75 ⁽¹⁾	170 140 ⁽¹⁾	M20 M20 ⁽¹⁾	85 79.5 ⁽¹⁾	22 20 ⁽¹⁾	600	550	660	23	6	25	1315	1145	1463	603	694	413	50	
BX 315SB				79.5 69 ⁽¹⁾	20 18 ⁽¹⁾							400	350	450					19
BX 315SC																			
BX 315MA	90 75 ⁽¹⁾			95 79.5 ⁽¹⁾	25 20 ⁽¹⁾	740	680	800	23	6	25	1315	1145	1463	603	694	413	50	
BX 355MA	100 75 ⁽¹⁾	210 170 ⁽¹⁾	M24 M20 ⁽¹⁾	106 79.5 ⁽¹⁾	28 20 ⁽¹⁾							740	680	800					23
BX 355MB																			
BX 355MC																			

N.B.: 1) These values refer to the rear shaft end (PS).

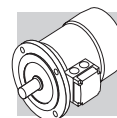

BX - IM B14

BX

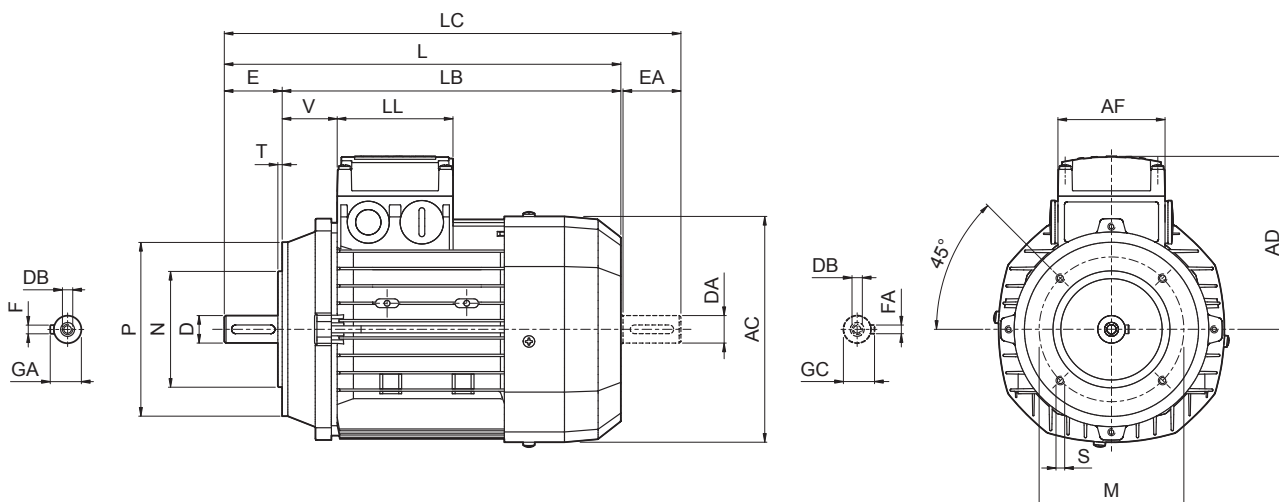

	Shaft					Housing					Motor							
	D DA	E EA	DB	GA GC	F FA	M	N	P	S	T	AC	L	LB	LC	AD	AF	LL	V
BX 80 B	19 14 ⁽¹⁾	4 30 ⁽¹⁾	M6 M5 ⁽¹⁾	21.5 16 ⁽¹⁾	6 5 ⁽¹⁾	100	80	120	M6	3	156	320	280	351	119	74	80	38
BX 90 S BX 90 LA	24 19 ⁽¹⁾	50 40 ⁽¹⁾	M8 M6 ⁽¹⁾	27 21.5 ⁽¹⁾	8 6 ⁽¹⁾	115	95	140	M8		176	326	276	368	133	98	98	44
BX 100 LA BX 100 LB	28 24 ⁽¹⁾	60 50 ⁽¹⁾	M10 M8 ⁽¹⁾	31 27 ⁽¹⁾	8 8 ⁽¹⁾	130	110	160		195	410	350	462	142	50			
BX 112 M										219	430	370	482	157	52			
BX 132 SB	38 28 ⁽¹⁾	80 60 ⁽¹⁾	M12 M10 ⁽¹⁾	41 31 ⁽¹⁾	10 8 ⁽¹⁾	165	130	200	M10	4	258	493	413	556	193	118	118	58

N.B.: 1) These values refer to the rear shaft end (PS).

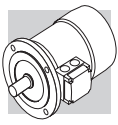

BX_FA/FD ; IM B3

BX

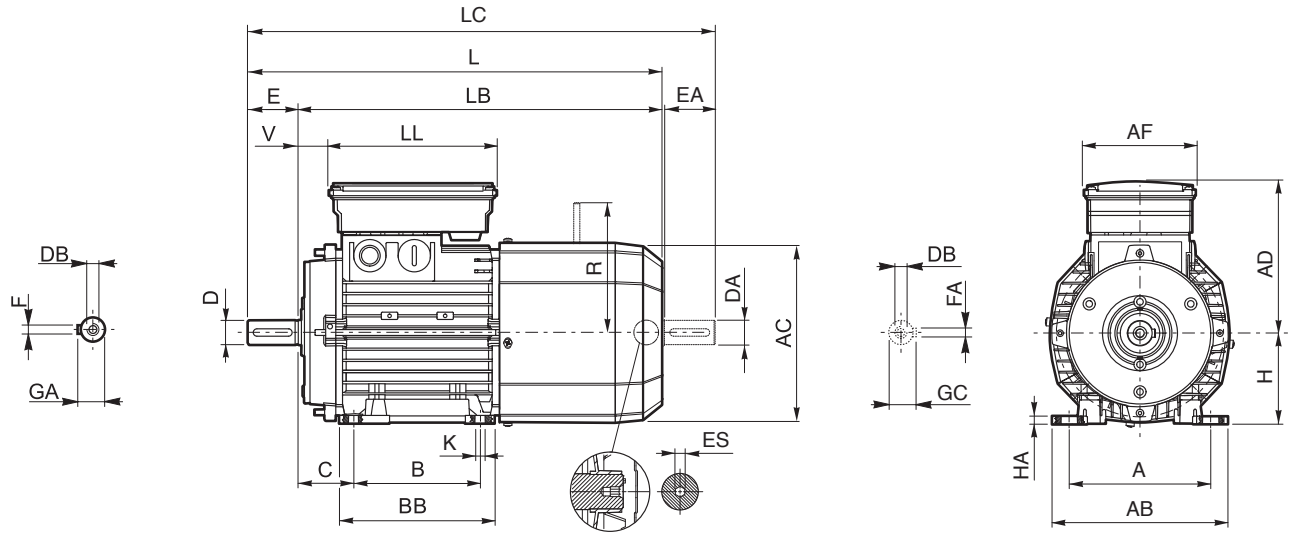

	Shaft					Housing						Motor													
	D	E	DB	GA	F	B	A	HA	BB	AB	K	C	H	AC	L	LB	LC	AD	AF	LL	V	R		ES	
	DA	EA	M	GC	FA																	FD	FA	(2)	
BX 80 B	19 14 ⁽¹⁾	40 30 ⁽¹⁾	M6	21.5 16 ⁽¹⁾	6 5 ⁽¹⁾	100	125		124	153		50	80	156	392	352	423	143	98	133	25		129	134	5
BX 90 S	24 19 ⁽¹⁾	50 40 ⁽¹⁾	M8	27 21.5 ⁽¹⁾	8 6 ⁽¹⁾	125	140	8	155	174	10	56	90	176	410	360	452	146			32				
BX 90 LA			M6 ⁽¹⁾																						
BX 100 LA			M10	31 27 ⁽¹⁾	8 8 ⁽¹⁾	140	160		175	192	12	63	100	195	502	442	554	155	110	165	37	160	160	6	
BX 100 LB	28 24 ⁽¹⁾	60 50 ⁽¹⁾	M8 ⁽¹⁾					10																	
BX 112 M						190				224		70	112	219	527	467	579	170			39	199	198		
BX 132 SB	38 28 ⁽¹⁾	80 60 ⁽¹⁾	M12	41 31 ⁽¹⁾	10 8 ⁽¹⁾	140	216	12	218	254	12	89	132	258	603	523	667		210	140	188	46	204	200	
BX 132 MA			M10 ⁽¹⁾			178									627	547	690						226		
BX 160 MA						210			264						596	486	680								
BX 160 MB	42 38 ⁽¹⁾	110 80 ⁽¹⁾	M16	45 41 ⁽¹⁾	12 10 ⁽¹⁾	254	254	25	304	319	14.5	108	160	310	640	530	724	245			51	266	247		
BX 160 L																			187	187					
BX 180 M	48 42 ⁽¹⁾	110 110 ⁽¹⁾	M16	51.5 45 ⁽¹⁾	14 12 ⁽¹⁾	241	279	26	291	359	14	121	180	348	866	598	823	261			25	305			
BX 180 L			M16 ⁽¹⁾			279			329																
BX 200LA	55 45 ⁽¹⁾			59 48.5 ⁽¹⁾	16 14 ⁽¹⁾	267	318		345	378		133	200	423	982	872	1095	328			55	320			
BX 225SA	60 55 ⁽¹⁾	140 110 ⁽¹⁾		64 59 ⁽¹⁾	18 16 ⁽¹⁾	286	356	23	351	435	18.5	149	225	465	1058	918	1180	348	300	311	48	445			
BX 225SB																									
BX 250MA	65 55 ⁽¹⁾			69 59 ⁽¹⁾		311	406		392	480	24	168	250	514	1099	959	1225	376							
BX 280SA	75 65 ⁽¹⁾	140 140 ⁽¹⁾	M20	79.5 69 ⁽¹⁾	20 18 ⁽¹⁾	368	457	31	506	530	24	190	280	567	1340	1200	1490	482	434	306	43	832			
BX 280SB			M20 ⁽¹⁾																						
BX 315SA															1452	1282	1600								
BX 315SB	80 75 ⁽¹⁾	170 140 ⁽¹⁾		85 79.5 ⁽¹⁾	22 20 ⁽¹⁾	406	508	40	558	590	28	216	315	645	1497	1327	1645	537	473	347	42				
BX 315SC																									
BX 315MA	90 75 ⁽¹⁾			95 79.5 ⁽¹⁾	25 20 ⁽¹⁾	457			669						1607	1437	1755								
BX 355MA															1790	1580	1970								
BX 355MB	100 75 ⁽¹⁾	210 170 ⁽¹⁾	M24	106 79.5 ⁽¹⁾	28 20 ⁽¹⁾	500	610	45	722	700	35	254	355	740	1825	1615	2005	603	694	413	50				
BX 355MC			M20 ⁽¹⁾																						

N.B.: 1) These values refer to the rear shaft end (PS). 2) "ES" hexagon is not present with PS option

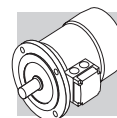

BX_FA/FD ; IM B5

BX

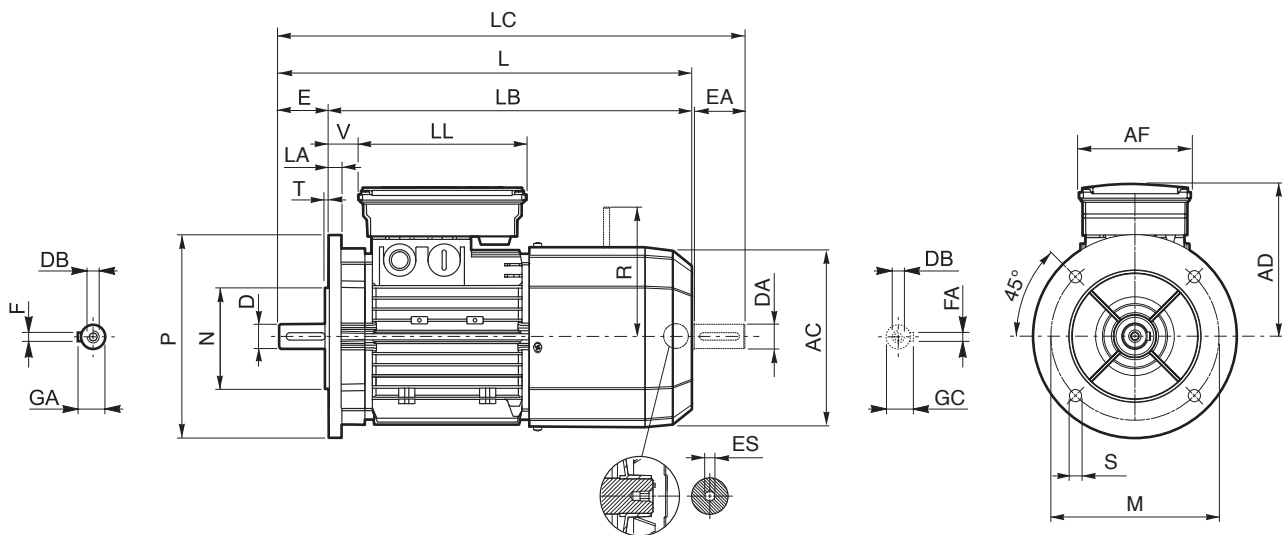

	Shaft					Flange						Motor										
	D DA	E EA	DB	GA GC	F FA	M	N	P	S	T	LA	AC	L	LB	LC	AD	AF	LL	V	R		ES ⁽²⁾
																				FD	FA	
BX 80 B	19 14 ⁽¹⁾	40 30 ⁽¹⁾	M6 M5 ⁽¹⁾	21.5 16 ⁽¹⁾	6 5 ⁽¹⁾							156	392	352	423	143	98	133	25			5
BX 90 S	24 19 ⁽¹⁾	50 40 ⁽¹⁾	M8 M6 ⁽¹⁾	27 21.5 ⁽¹⁾	8 6 ⁽¹⁾	165	130	200	11.5	3.5	11.5	176	410	360	452	146			32			
BX 90 LA																						
BX 100 LA																						
BX 100 LB	28 24 ⁽¹⁾	60 50 ⁽¹⁾	M10 M8 ⁽¹⁾	31 27 ⁽¹⁾	8 8 ⁽¹⁾	215	180	250			14	195	502	442	554	155		110	165	37	160	160
BX 112 M									14	4	15	219	527	467	579	170			39	199	198	6
BX 132 SB	38 28 ⁽¹⁾	80 60 ⁽¹⁾	M12 M10 ⁽¹⁾	41 31 ⁽¹⁾	10 8 ⁽¹⁾	265	230	300			16	258	603	523	667		210	140	188	46	204	200
BX 132 MA													627	547	690						226	
BX 160 MA													736	626	820							
BX 160 MB	42 38 ⁽¹⁾	110 80 ⁽¹⁾	M16 M12 ⁽¹⁾	45 41 ⁽¹⁾	12 10 ⁽¹⁾						15	310				245			51	266	247	
BX 160 L						300	250	350	18.5	5			780	670	864		187	187				
BX 180 M	48 42 ⁽¹⁾		M16 M16 ⁽¹⁾	51.5 45 ⁽¹⁾	14 12 ⁽¹⁾						18	348	866	756	981	261			52	305		
BX 180 L		110 110 ⁽¹⁾																				
BX 200LA	55 45 ⁽¹⁾			59 48.5 ⁽¹⁾	16 14 ⁽¹⁾	350	300	400				423	982	872	1095	328			55	320		
BX 225SA	60 55 ⁽¹⁾			64 59 ⁽¹⁾	18 16 ⁽¹⁾	400	350	450	19		20	465	1058	918	1180	348	300	311	48	445		
BX 225SB		140 110 ⁽¹⁾																				
BX 250MA	65 55 ⁽¹⁾			69 59 ⁽¹⁾						5	24	514	1099	959	1225	376				832		
BX 280SA	75 65 ⁽¹⁾	140 140 ⁽¹⁾	M20 M20 ⁽¹⁾	79.5 69 ⁽¹⁾	20 18 ⁽¹⁾	500	450	550	18		23	567	1340	1200	1490	482	434	306	43	832		
BX 280SB																						
BX 315SA													1452	1282	1600					832		
BX 315SB	80 75 ⁽¹⁾			85 79.5 ⁽¹⁾	22 20 ⁽¹⁾	600	550	660				645	1497	1327	1645	537	473	347	42			
BX 315SC		170 140 ⁽¹⁾																				
BX 315MA	90 75 ⁽¹⁾			95 79.5 ⁽¹⁾	25 20 ⁽¹⁾				23	6	25		1607	1437	1755							
BX 355MA													1790	1580	1970							
BX 355MB	100 75 ⁽¹⁾	210 170 ⁽¹⁾	M24 M20 ⁽¹⁾	106 79.5 ⁽¹⁾	28 20 ⁽¹⁾	740	680	800				740				603	694	413	50			
BX 355MC													1825	1615	2005							

N.B.: 1) These values refer to the rear shaft end (PS). 2) "ES" hexagon is not present with PS option

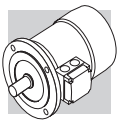

BX_FA/FD ; IM B14

BX

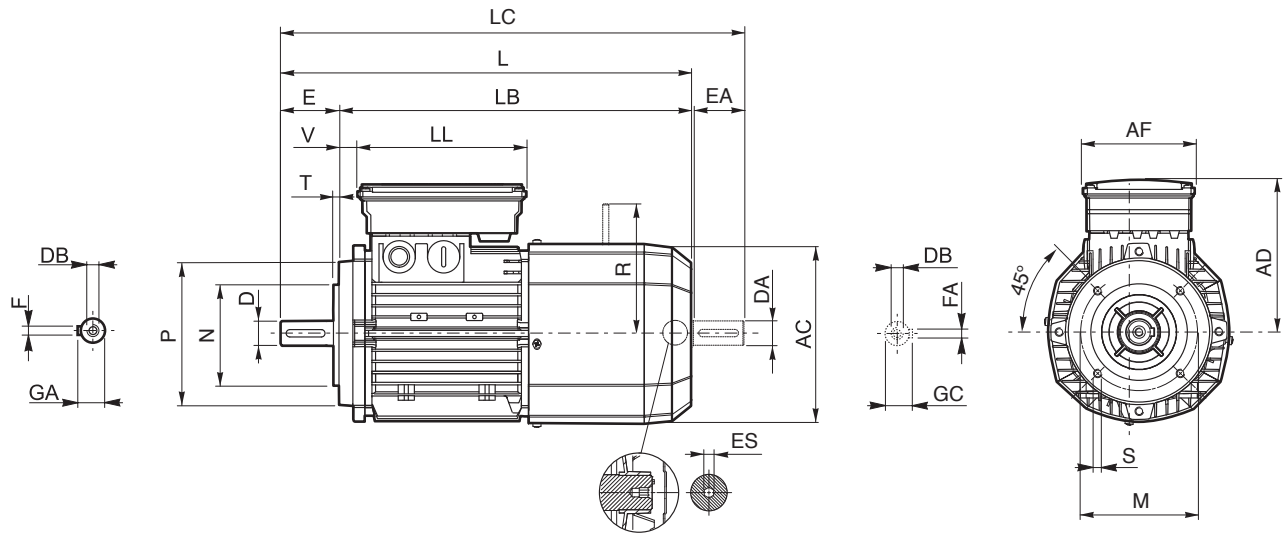

	Shaft					Housing					Motor										
	D DA	E EA	DB	GA GC	F FA	M	N	P	S	T	AC	L	LB	LC	AD	AF	LL	V	R		ES (2)
																			FD	FA	
BX 80 B	19 14 ⁽¹⁾	40 30 ⁽¹⁾	M6 M5 ⁽¹⁾	21.5 16 ⁽¹⁾	6 5 ⁽¹⁾	100	80	120	M6	3	156	392	352	423	143	98	133	25	129	134	5
BX 90 S	24 19 ⁽¹⁾	50 40 ⁽¹⁾	M8 M6 ⁽¹⁾	27 21.5 ⁽¹⁾	8 6 ⁽¹⁾	115	95	140	M8		176	410	360	452	146	110	165	32	160	160	
BX 90 LA											195	502	442	554	155						
BX 100 LA	28 24 ⁽¹⁾	60 50 ⁽¹⁾	M10 M8 ⁽¹⁾	31 27 ⁽¹⁾	8 8 ⁽¹⁾	130	110	160	M8	3.5	219	527	467	579	170	140	188	46	199	198	
BX 100 LB										603	523	667	210	200							
BX 112 M										258	627	547	690	226							
BX 132 SB	38 28 ⁽¹⁾	80 60 ⁽¹⁾	M12 M10 ⁽¹⁾	41 31 ⁽¹⁾	10 8 ⁽¹⁾	165	130	200	M10	4	603	523	667	210	140	188	46	204	200		
BX 132 MA											627	547	690	226							

N.B.: 1) These values refer to the rear shaft end (PS). 2) "ES" hexagon is not present with PS option

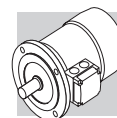

BX - CUS - IM B3

BX

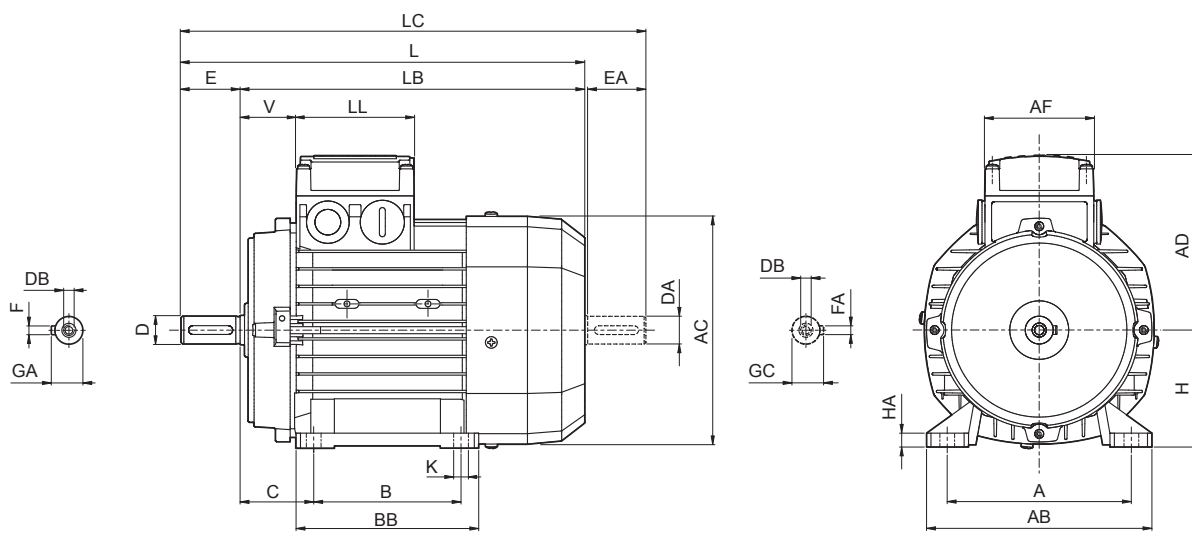

	Shaft					Housing						Motor													
	D DA	E EA	DB GC	GA GC	F FA	B	A	HA	BB	AB	K	C	H	AC	L	LB	LC	AD	AF	LL	V				
BX 90 SR	19 19 ⁽¹⁾	40 40 ⁽¹⁾	M6 M6 ⁽¹⁾	21.5 21.5 ⁽¹⁾	6 6 ⁽¹⁾	100	140	8	155	174	10	56	90	176	316	358	133	98	98	44					
BX 90 S	24 19 ⁽¹⁾	50 40 ⁽¹⁾	M8 M6(1)	27 21.5 ⁽¹⁾	8 6 ⁽¹⁾										326	378									
BX 90 LA						125																			
BX 100 LA	28 24 ⁽¹⁾	60 50 ⁽¹⁾	M10 M8 ⁽¹⁾	31 27 ⁽¹⁾	8 8 ⁽¹⁾	140	160	10	175	192	12	63	100	195	410	350	462	142	118	118	50				
BX 100 LB							190			224		70	112	219	430	370	482	157			52				
BX 112 M							216			254		89	132	258	552	472	615	193			58				
BX 132 SB	38 28 ⁽¹⁾	80 60 ⁽¹⁾	M12 M10 ⁽¹⁾	41 31 ⁽¹⁾	10 8 ⁽¹⁾	178	216	12	218	254	12	89	132	258	552	472	615	193	118	118	58				
BX 132 MA																									
BX 160 MA	42 38 ⁽¹⁾	110 80 ⁽¹⁾	M16 M12 ⁽¹⁾	45 41 ⁽¹⁾	12 10 ⁽¹⁾	210	254	254	25	264	14.5	108	160	310	596	486	680	245	187	187	51				
BX 160 MB						254				319					14.5	108	160				310	640	530	724	51
BX 160 L						254				319					14.5	108	160				310	640	530	724	187
BX 180 M	48 42 ⁽¹⁾	110 110 ⁽¹⁾	M16 M16 ⁽¹⁾	51.5 45 ⁽¹⁾	14 12 ⁽¹⁾	241	279	279	26	291	14	121	180	348	708	598	823	261	300	311	52				
BX 180 L	279					329				359					329										
BX 200LAK	55 45 ⁽¹⁾	140 110 ⁽¹⁾	M20 M16 ⁽¹⁾	59 48.5 ⁽¹⁾	16 14 ⁽¹⁾	267	318	23	345	378	18.5	133	200	417	821	711	934	328	300	311	55				
BX 225SAK	60 55 ⁽¹⁾					286	356		351	435		149	225	460	879	739	1001	348			48				
BX 225SBK	64 59 ⁽¹⁾					18 16 ⁽¹⁾	311		406	392		480	168	250	510	884	744	1010			376				
BX 250MAK	65 55 ⁽¹⁾	140 140 ⁽¹⁾	M20 M20 ⁽¹⁾	79.5 69 ⁽¹⁾	20 18 ⁽¹⁾	368	457	31	506	530	24	190	280	564	1088	948	1238	482	434	306	43				
BX 280SAK	75 65 ⁽¹⁾					406	508	40	558	590	28	216	315	639	1204	1034	1352	537	473	347	42				
BX 280SBK	79.5 69 ⁽¹⁾					22 20 ⁽¹⁾	406	508	40	558	590	28	216	315	639	1315	1145	1453	537	473	347	42			
BX 315SAK	80 75 ⁽¹⁾	170 140 ⁽¹⁾	M20 M20 ⁽¹⁾	85 79.5 ⁽¹⁾	22 20 ⁽¹⁾	406	508	40	558	590	28	216	315	639	1204	1034	1352	537	473	347	42				
BX 315SBK															1315	1145	1453								
BX 315SCK															1315	1145	1453								
BX 355SAK	100 75 ⁽¹⁾	210 170 ⁽¹⁾	M24 M20 ⁽¹⁾	106 79.5 ⁽¹⁾	28 20 ⁽¹⁾	500	610	45	722	700	35	254	355	740	1479	1269	1659	603	694	413	50				
BX 355MAK															1584	1374	1765								
BX 355MBK															1584	1374	1765								
BX 355MCK	1584	1374	1765																						

N.B.: 1) These values refer to the rear shaft end (PS).

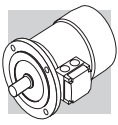

BX - CUS - IM B5

BX

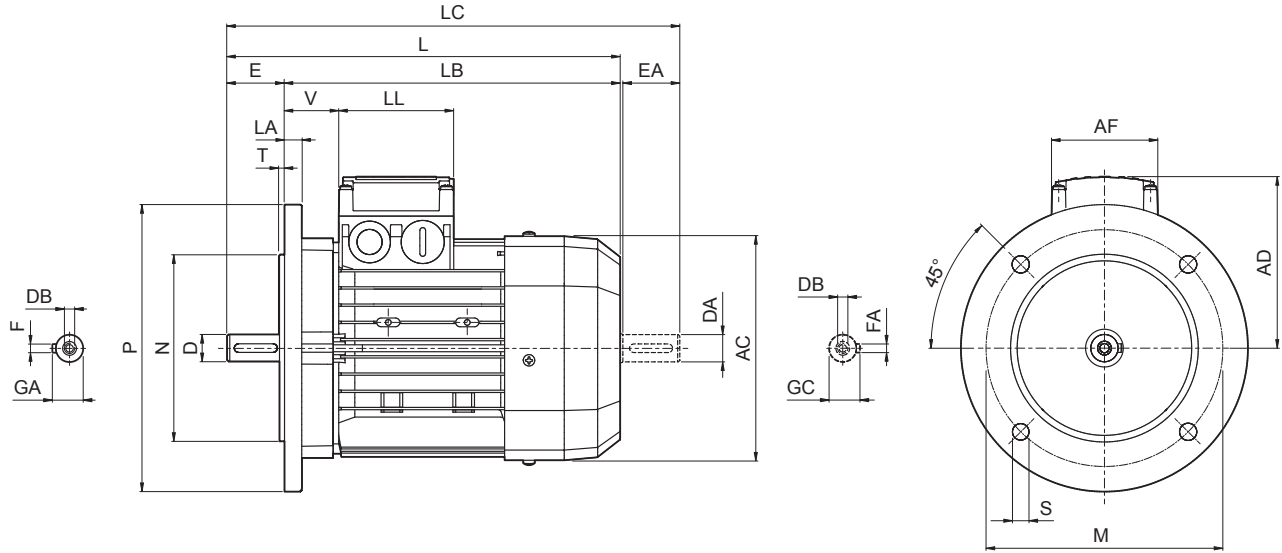

	Shaft					Flange						Motor								
	D DA	E EA	DB	GA GC	F FA	M	N	P	S	T	LA	AC	L	LB	LC	AD	AF	LL	V	
BX 90SR	19	40	M6	21.5	6	165	130	200	11.5	3.5	11.5	176	316	276	358	133			44	
BX 90LA	19 ⁽¹⁾	40 ⁽¹⁾	M6 ⁽¹⁾	21.5 ⁽¹⁾	6 ⁽¹⁾															
BX 100LA	28 24 ⁽¹⁾	60 50 ⁽¹⁾	M10 M8 ⁽¹⁾	31 27 ⁽¹⁾	8 8 ⁽¹⁾	215	180	250	14	4	14	195	410	350	462	142	98	98	50	
BX 100LB											15	219	430	370	482	157			52	
BX 112M											20	258	552	472	615	193	118	118	58	
BX 132SB	38	80	M12	41	10	265	230	300												
BX 132MA	28 ⁽¹⁾	60 ⁽¹⁾	M10 ⁽¹⁾	31 ⁽¹⁾	8 ⁽¹⁾															
BX 160MA	42 38 ⁽¹⁾	110 80 ⁽¹⁾	M16 M12 ⁽¹⁾	45 41 ⁽¹⁾	12 10 ⁽¹⁾	300	250	350	18.5	5	15	310	596	486	680	245			51	
BX 160MB											18	348	708	598	823	261	187	187	52	
BX 160L											19	423	821	711	934	328			55	
BX 180M	48 42 ⁽¹⁾	110 110 ⁽¹⁾	M16 M16 ⁽¹⁾	51.5 45 ⁽¹⁾	14 12 ⁽¹⁾	350	300	400	19	5	20	465	879	739	1001	348	300	311	48	
BX 180L											24	514	884	744	1010	376				
BX 200LAK											23	567	1088	948	1238	482	434	306	43	
BX 225SAK	60 55 ⁽¹⁾	140 110 ⁽¹⁾	M20 M20 ⁽¹⁾	64 59 ⁽¹⁾	18 16 ⁽¹⁾	400	350	450	18	6	25	20	423	821	711	934	328			
BX 225SBK												24	514	884	744	1010	376			
BX 250MAK												23	567	1088	948	1238	482	434	306	43
BX 280SAK	75 65 ⁽¹⁾	140 140 ⁽¹⁾	M20 M20 ⁽¹⁾	79.5 69 ⁽¹⁾	20 18 ⁽¹⁾	500	450	550	18	6	25	23	567	1088	948	1238	482	434	306	43
BX 280SBK												23	567	1088	948	1238	482	434	306	43
BX 315SAK												23	567	1088	948	1238	482	434	306	43
BX 315SBK	80 75 ⁽¹⁾	170 140 ⁽¹⁾	M20 M20 ⁽¹⁾	85 79.5 ⁽¹⁾	22 20 ⁽¹⁾	600	550	660	18	6	25	23	567	1088	948	1238	482	434	306	43
BX 315SCK												23	567	1088	948	1238	482	434	306	43
BX 355SAK												23	567	1088	948	1238	482	434	306	43
BX 355MAK	100 75 ⁽¹⁾	210 170 ⁽¹⁾	M24 M20 ⁽¹⁾	106 79.5 ⁽¹⁾	28 20 ⁽¹⁾	740	680	800	18	6	25	23	567	1088	948	1238	482	434	306	43
BX 355MBK												23	567	1088	948	1238	482	434	306	43
BX 355MCK												23	567	1088	948	1238	482	434	306	43

N.B.: 1) These values refer to the rear shaft end (PS).

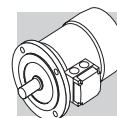

BX - CUS - IM B14

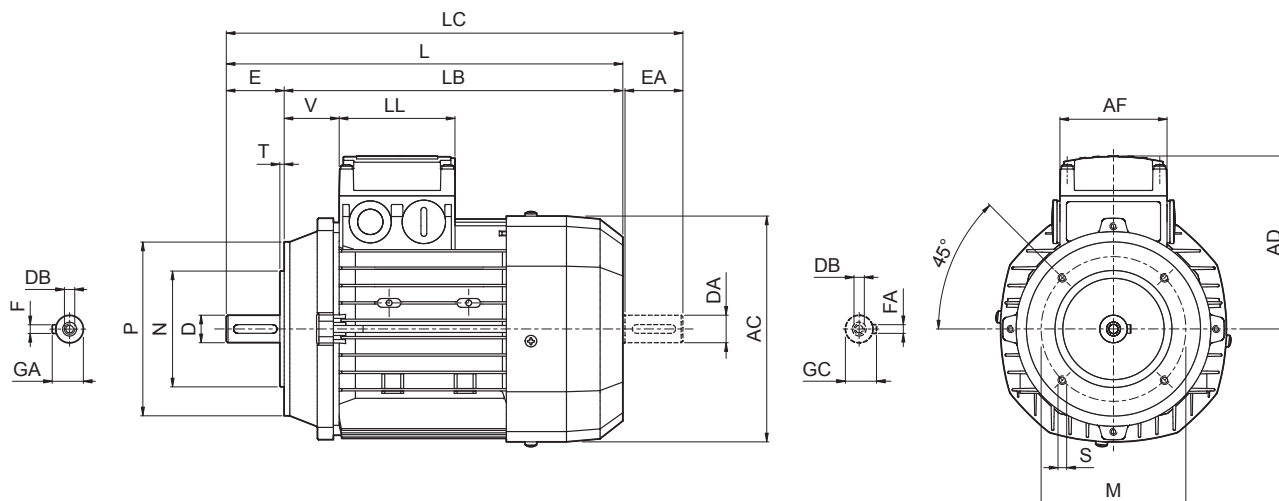

BX

	Shaft					Housing					Motor							
	D DA	E EA	DB	GA GC	F FA	M	N	P	S	T	AC	L	LB	LC	AD	AF	LL	V
BX 90 SR	19 19 ⁽¹⁾	40 40 ⁽¹⁾	M6 M6 ⁽¹⁾	21.5 21.5 ⁽¹⁾	6 6 ⁽¹⁾	100	80	120	M6			316		358				
BX 90 S	24 19 ⁽¹⁾	50 40 ⁽¹⁾	M8 M6 ⁽¹⁾	27 21.5 ⁽¹⁾	8 6 ⁽¹⁾	115	95	140	M8	3	176	326	276	368	133	98	98	44
BX 90 LA																		
BX 100 LA	28 24 ⁽¹⁾	60 50 ⁽¹⁾	M10 M8 ⁽¹⁾	31 27 ⁽¹⁾	8 8 ⁽¹⁾	130	110	160	M8	3.5	195	410	350	462	142	98	98	50
BX 100 LB																		
BX 112 M																		
BX 132 SB	38 28 ⁽¹⁾	80 60 ⁽¹⁾	M12 M10 ⁽¹⁾	41 31 ⁽¹⁾	10 8 ⁽¹⁾	165	130	200	M10	4	258	552	472	615	193	118	118	58
BX 132 MA																		

N.B.: 1) These values refer to the rear shaft end (PS).

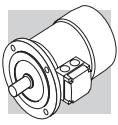

BX_FA/FD CUS ; IM B3

BX

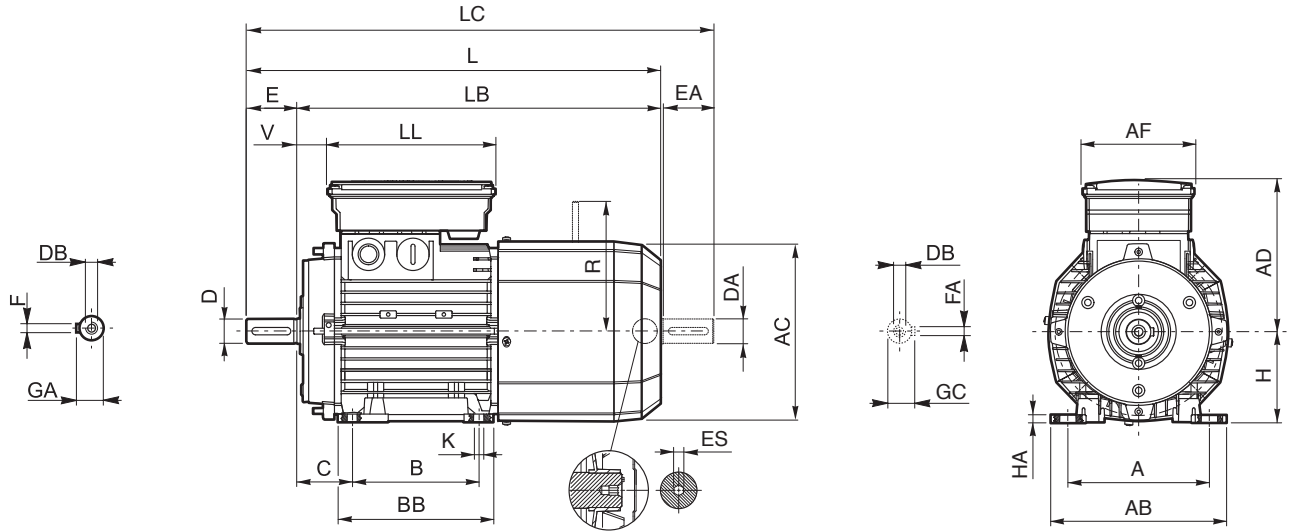

	Shaft					Housing						Motor													
	D DA	E EA	DB	GA GC	F FA	B	A	HA	BB	AB	K	C	H	AC	L	LB	LC	AD	AF	LL	V	R		ES ⁽²⁾	
																						FD	FA		
BX 90 SR	19 19 ⁽¹⁾	40 40 ⁽¹⁾	M6 M6 ⁽¹⁾	21.5 21.5 ⁽¹⁾	6 6 ⁽¹⁾	100									400		442								
BX 90 S	24 19 ⁽¹⁾	50 40 ⁽¹⁾	M8 M6 ⁽¹⁾	27 21.5 (1)	8 6 ⁽¹⁾	140	8	155	174	10	56	90	176		410	360	452	146			32	129	134		
BX 90 LA						125													110	165					
BX 100 LA																									
BX 100 LB	28 24 ⁽¹⁾	60 50 ⁽¹⁾	M10 M8 ⁽¹⁾	31 27 ⁽¹⁾	8 8 ⁽¹⁾	140	160	10	175	192		63	100	195	502	442	554	155			37	160	160	6	
BX 112 M						190				224	12	70	112	219	527	467	579	170			39	199	198		
BX 132 SB	38 28 ⁽¹⁾	80 60 ⁽¹⁾	M12 M10 ⁽¹⁾	41 31 ⁽¹⁾	10 8 ⁽¹⁾	140	216	12	218	254		89	132	258	661	581	724	210	140	188	46	204	200		
BX 132 MA						178																	226		
BX 160 MA						210			264						596	486	680								
BX 160 MB	42 38 ⁽¹⁾	110 80 ⁽¹⁾	M16 M12 ⁽¹⁾	45 41 ⁽¹⁾	12 10 ⁽¹⁾	254	254	25	304	319	14.5	108	160	310	640	530	724	245			51	266	247		
BX 160 L																			187	187					
BX 180 M	48 42 ⁽¹⁾	110 110 ⁽¹⁾	M16 M16 ⁽¹⁾	51.5 45 ⁽¹⁾	14 12 ⁽¹⁾	241	279	26	291	359	14	121	180	348	866	598	823	261			52	305			
BX 180 L						279			329																
BX 200LAK	55 45 ⁽¹⁾		M20 M16 ⁽¹⁾	59 48.5 ⁽¹⁾	16 14 ⁽¹⁾	267	318		345	378		133	200	417	967	857	1082	328			55	323			
BX 225SAK	60 55 ⁽¹⁾	140 110 ⁽¹⁾		64 59 ⁽¹⁾	18 16 ⁽¹⁾	286	356	23	351	435	18.5	149	225	460	1065	925	1180	348	300	311	48	308			
BX 225SBK						311	406		392	480		168	250	510	1070	930	1240	376				363			
BX 250MAK	65 55 ⁽¹⁾			69 59 ⁽¹⁾																					
BX 280SAK	75 65 ⁽¹⁾	140 140 ⁽¹⁾	M20 M20 ⁽¹⁾	79.5 69 ⁽¹⁾	20 18 ⁽¹⁾	368	457	31	506	530	24	190	280	564	1284	1144	1379	482	434	306	43	500	—		
BX 280SBK																									
BX 315SAK															1493	1323	1643								
BX 315SBK	80 75 ⁽¹⁾	170 140 ⁽¹⁾		85 79.5 ⁽¹⁾	22 20 ⁽¹⁾	406	508	40	558	590	28	216	315	639	1530	1360	1680	537	473	347	42				
BX 315SCK															1604	1434	1791						678		
BX 355SAK																									
BX 355MAK	100 75 ⁽¹⁾	210 170 ⁽¹⁾	M24 M20 ⁽¹⁾	106 79.5 ⁽¹⁾	28 20 ⁽¹⁾	500	610	45	722	700	35	254	355	725	1722	1512	1902	603	694	413	50	—			
BX 355MBK																									
BX 355MCK															1827	1617	2082								

N.B.: 1) These values refer to the rear shaft end (PS). 2) "ES" hexagon is not present with PS option

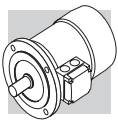

BX_FA/FD CUS ; IM B14

BX

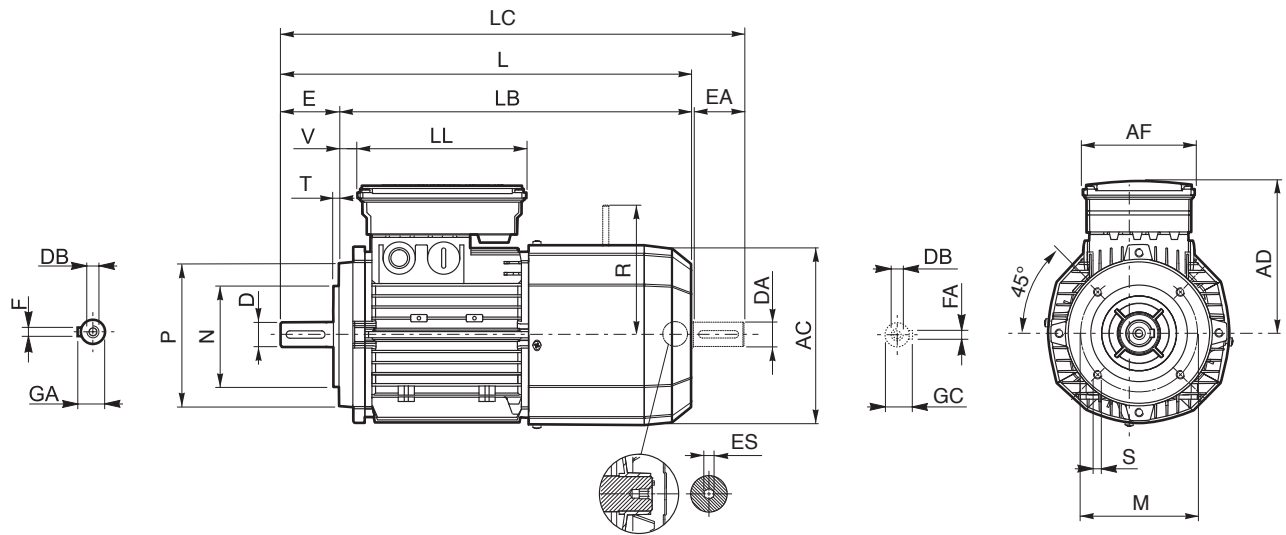

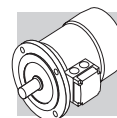

	Shaft					Housing					Motor										
	D DA	E EA	DB	GA GC	F FA	M	N	P	S	T	AC	L	LB	LC	AD	AF	LL	V	R		ES ⁽²⁾
																			FD	FA	
BX 90 SR	19 19 ⁽¹⁾	40 40 ⁽¹⁾	M6 M6 ⁽¹⁾	21.5 21.5 ⁽¹⁾	6 6 ⁽¹⁾	100	80	120	M6			400		442					129	134	
BX 90 S	24 19 ⁽¹⁾	50 40 ⁽¹⁾	M8 M6 ⁽¹⁾	27 21.5 ⁽¹⁾	8 6 ⁽¹⁾	115	95	140	M8	3	176	360	452	146	110	165	32	37	160	160	6
BX 90 LA																					
BX 100 LA	28 24 ⁽¹⁾	60 50 ⁽¹⁾	M10 M8 ⁽¹⁾	31 27 ⁽¹⁾	8 8 ⁽¹⁾	130	110	160	M8	3.5	195	502	442	554	155	110	165	37	160	160	6
BX 100 LB																					
BX 112 M																					
BX 132 SB	38 28 ⁽¹⁾	80 60 ⁽¹⁾	M12 M10 ⁽¹⁾	41 31 ⁽¹⁾	10 8 ⁽¹⁾	165	130	200	M10	4	258	661	581	724	210	140	188	46	204	200	
BX 132 MA																				226	

N.B.: 1) These values refer to the rear shaft end (PS). 2) "ES" hexagon is not present with PS option



15 MOTOR RATING CHARTS BE



2 P		3000 min ⁻¹ - S1										50 Hz - IE2		
P _n kW		n min ⁻¹	M _n Nm	I _n 400V A	η%			cos φ	$\frac{I_s}{I_n}$	$\frac{M_s}{M_n}$	$\frac{M_a}{M_n}$	J _m x 10 ⁻⁴ kgm ²	IM B5 Kg	
					100%	75%	50%							
0.75	BE 80A	2	2860	2.5	1.65	80.0	79.6	76.4	0.83	6.8	3.8	3.5	9.0	9.5
1.1	BE 80B	2	2845	3.7	2.35	81.5	82.2	79.9	0.83	6.9	3.8	3.1	11.4	11.3
1.5	BE 90SA	2	2865	5.0	3.2	81.3	80.7	78.1	0.82	6.8	3.6	2.8	12.5	12.3
2.2	BE 90L	2	2870	7.3	4.7	83.2	83.1	80.8	0.82	6.9	3.1	2.9	16.7	14
3	BE 100L	2	2880	9.9	6.2	84.6	84.6	83.7	0.83	7.3	3.5	3.1	39	23
4	BE 112M	2	2920	13.1	8.2	85.8	85.5	84.3	0.82	7.9	3.5	3.1	57	28
5.5	BE 132SA	2	2925	18.0	10.6	87.0	85.0	81.7	0.86	8.5	3.6	3.3	145	42
7.5	BE 132SB	2	2935	24	14.3	88.1	87.4	84.7	0.86	8.8	3.9	3.6	178	53
9.2	BE 132MB	2	2920	30	16.4	88.8	86.5	84.2	0.91	8.4	3.7	3.3	210	65
11	BE 160MA	2	2940	36	20.0	89.4	89.5	88.0	0.89	8.1	3.0	2.9	340	84
15	BE 160MB	2	2950	49	27.2	90.5	90.5	89.5	0.88	8.5	3.0	2.8	420	97
18.5	BE 160L	2	2945	60	32	90.9	90.5	89.8	0.91	7.7	2.9	2.7	490	109

4 P		1500 min ⁻¹ - S1										50 Hz - IE2		
P _n kW		n min ⁻¹	M _n Nm	I _n 400V A	η%			cos φ	$\frac{I_s}{I_n}$	$\frac{M_s}{M_n}$	$\frac{M_a}{M_n}$	J _m x 10 ⁻⁴ kgm ²	IM B5 Kg	
					100%	75%	50%							
0.37	BE 71B	4	1385	2.55	1.05	70.1	69.3	64.2	0.75	4.0	2.3	2.2	6.9	5.9
0.55	BE 80A	4	1405	3.7	1.41	75.1	74.9	71.2	0.76	4.3	2.2	1.9	15	8.2
0.75	BE 80B	4	1430	5.0	1.65	81.0	80.5	78.0	0.81	6.1	3.2	3.0	28	12.2
1.1	BE 90S	4	1430	7.4	2.53	82.5	82.0	79.5	0.76	6.3	2.9	2.8	28	13.6
1.5	BE 90LA	4	1430	10.0	3.5	83.5	83.0	80.0	0.74	5.9	3.1	3.0	34	15.1
2.2	BE 100LA	4	1430	14.7	4.9	85.4	85.0	84.0	0.76	5.8	3.0	2.8	54	22
3	BE 100LB	4	1420	20	6.6	85.5	86.0	85.5	0.77	5.9	2.8	2.6	61	24
4	BE 112M	4	1440	27	8.3	87.0	87.0	86.0	0.80	6.5	2.8	2.8	105	32
5.5	BE 132S	4	1460	36	11.1	88.5	88.5	87.5	0.81	7.3	2.9	2.9	270	53
7.5	BE 132MA	4	1460	49	14.8	89.0	89.0	88.5	0.82	6.9	2.9	2.8	319	59
9.2	BE 132MB	4	1460	60	18.1	89.5	89.5	88.5	0.82	6.9	2.9	3.0	360	70
11	BE 160M	4	1465	72	21.5	91.0	91.3	90.5	0.81	6.5	2.8	2.6	650	99
15	BE 160L	4	1465	98	28.7	90.8	91.0	90.5	0.83	6.5	2.6	2.3	790	115
18.5	BE 180M	4	1465	121	35	91.6	92.0	91.3	0.83	6.5	2.6	2.5	1250	135
22	BE 180L	4	1465	143	41	91.6	91.8	91.4	0.84	6.8	2.7	2.6	1650	157

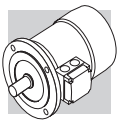
BE



6 P	1000 min⁻¹ - S1	50 Hz - IE2
------------	-----------------------------------	--------------------

P _n kW		n min ⁻¹	M _n Nm	I _n 400V A	η%			cos φ	$\frac{I_s}{I_n}$	$\frac{M_s}{M_n}$	$\frac{M_a}{M_n}$	J _m x 10 ⁻⁴ kgm ²	IM B5 
					100%	75%	50%						
0.75	BE 90S 6	935	7.7	2.06	75.9	75.9	73.0	0.69	5.1	3.1	2.9	33	15
1.1	BE 100M 6 (*)	945	11.1	2.75	78.1	76.2	73.0	0.74	4.9	2.2	1.9	82	22
1.5	BE 100LA 6	945	15.2	3.9	79.8	77.5	74.0	0.72	5.6	2.5	2.3	95	24
2.2	BE 112M 6	950	22	5.2	81.8	81.8	79.3	0.74	5.2	2.6	2.3	168	32
3	BE 132S 6	955	30	6.6	83.3	83.3	82.4	0.79	6.1	2.1	1.9	295	44
4	BE 132MA 6	965	40	8.7	84.6	85.0	83.1	0.79	6.9	2.2	2.0	383	56
5.5	BE 160MA 6 (*)	965	54	11.6	87.0	87.0	86.4	0.79	6.6	2.5	2.3	740	83
7.5	BE 160MB 6 (*)	965	74	15.0	88.0	88.0	87.2	0.82	6.6	2.3	2.1	970	103

(*) Power /size relation not standardized

BE

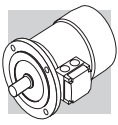

BE - IM B5

BE

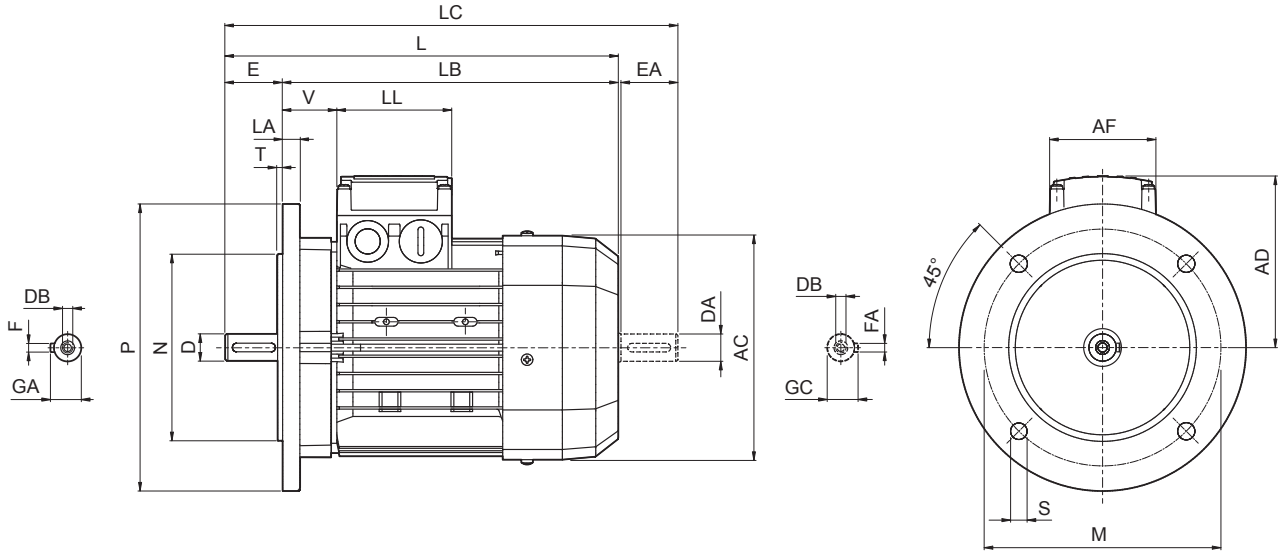

	Shaft					Flange					Motor									
	D DA	E EA	DB	GA GC	F FA	M	N	P	S	T	LA	AC	L	LB	LC	AD	AF	LL	V	
BE 71	14	30	M5	16	5	130	110	160	9.5	3.5	10	138	249	219	281	108	74	80	37	
BE 80	19	40	M6	21.5	6	165	130	200	11.5		11.5	156	274	234	315	119			133	98
BE 90 S	24	50	M8	27	8						215	180	250	14	4	176	326	276		
BE 90 L						50	52													
BE 100	28	60	M10	31	10	265	230	300	14	4	14	195	367	307	429	193	118	118	50	
BE 112											15	219	385	325	448	157			58	
BE 132 S	38	80	M12	41	10	300	350	18.5	5	18	20	258	493	413	576	245	187	187	51	
BE 132 MA													528	448	611					
BE 132 MB													596	486	680					
BE 160 M	42	110	M16	45	12	300	250	350	18.5	5	15	310	640	530	724	261	187	187	52	
BE 160 L	38 ⁽¹⁾	80 ⁽¹⁾	M12 ⁽¹⁾	41 ⁽¹⁾	10 ⁽¹⁾								640	530	724					
BE 180 M	48	110	M16	51.5	14	300	250	350	18.5	5	18	348	708	598	823	261	187	187	52	
BE 180 L																				42 ⁽¹⁾

N.B.:

1) These values refer to the rear shaft end.

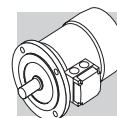

BE - IM B14

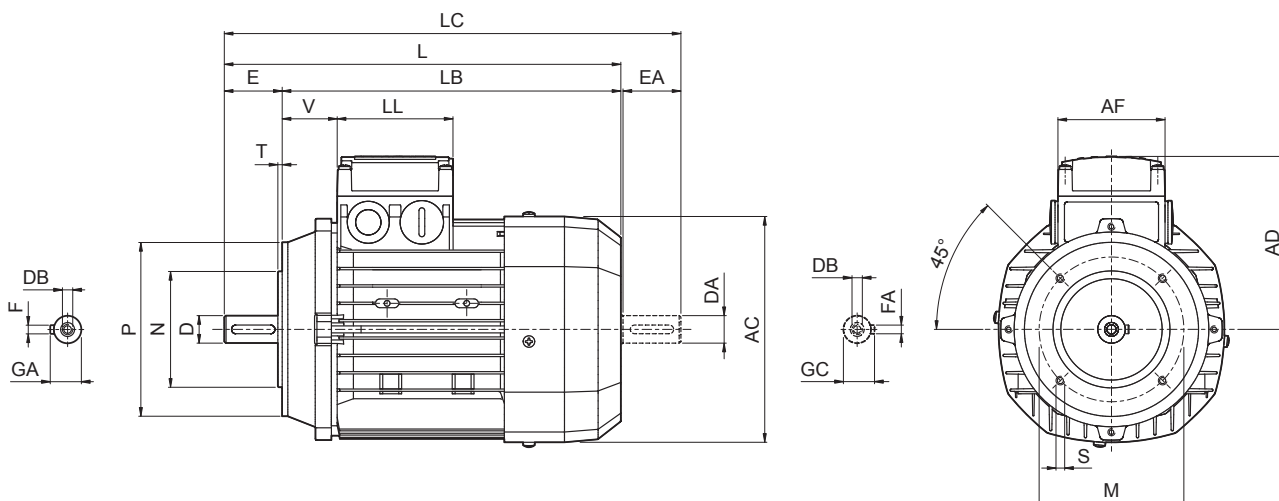

BE

	Shaft					Flange					Motor								
	D DA	E EA	DB	GA GC	F FA	M	N	P	S	T	AC	L	LB	LC	AD	AF	LL	V	
BE 71	14	30	M5	16	5	85	70	105	M6	2.5	138	249	219	281	108	74	80	37	
BE 80	19	40	M6	21.5	6	100	80	120			156	274	234	315				119	38
BE 90 S	24	50	M8	27	8	115	95	140	M8	3	176	326	276	378	133	98	98	44	
BE 90 L																			195
BE 100	28	60	M10	31		130	110	160			3.5	219	385	325	448			157	52
BE 112												493	413	576	193			118	118
BE 132 S	38	80	M12	41	10	165	130	200	M10	4	258	528	448	611					
BE 132 MA																			
BE 132 MB																			

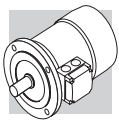

17 MOTOR RATING CHARTS BN

BN

2P		3000 min ⁻¹ - S1														50 Hz											
P _n kW		n min ⁻¹	M _n Nm	IE1	η (100%) %	η (75%) %	η (50%) %	cosφ	In 400V A	Is In	Ms Mn	Ma Mn	J _m x 10 ⁻⁴ kgm ²	IM B5 Kg	d.c. brake						a.c. brake						
															FD			FA			FD			FA			
															Mod	Mb Nm	Z _o 1/h	SB	Mod	Mb Nm	Z _o 1/h	IM B5 Kg	Mod	Mb Nm	Z _o 1/h	IM B5 Kg	
0.18	BN 63A	2	2730	0.63	○	59.9	56.9	51.9	0.77	0.56	3.0	2.1	2.0	2.0	3.5	FD 02	1.75	3900	4800	2.6	5.2	FA 02	1.75	4800	4800	2.6	5.0
0.25	BN 63B	2	2740	0.87	○	66.0	64.8	64.8	0.76	0.72	3.3	2.3	2.3	2.3	3.9	FD 02	1.75	3900	4800	3.0	5.6	FA 02	1.75	4800	4800	3.0	5.4
0.37	BN 63C	2	2800	1.26	○	69.1	66.8	66.8	0.78	0.99	3.9	2.6	2.6	3.3	5.1	FD 02	3.5	3600	4500	3.9	6.8	FA 02	3.5	4500	4500	3.9	6.6
0.37	BN 71A	2	2820	1.25	○	73.8	73.0	70.6	0.76	0.95	4.8	2.8	2.6	3.5	5.4	FD 03	3.5	3000	4100	4.6	8.1	FA 03	3.5	4200	4200	4.6	7.8
0.55	BN 71B	2	2820	1.86	○	76.0	75.8	74.8	0.76	1.37	5.0	2.9	2.8	4.1	6.2	FD 03	5	2900	4200	5.3	8.9	FA 03	5	4200	4200	5.3	8.6
0.75	BN 71C	2	2810	2.6	○	76.6	76.2	76.2	0.76	1.86	5.1	3.1	2.8	5.0	7.3	FD 03	5	1900	3300	6.1	10.0	FA 03	5	3600	3600	6.1	9.7
0.75	BN 80A	2	2810	2.6	●	76.2	75.5	88.3	0.81	1.75	4.8	2.6	2.2	7.8	8.6	FD 04	5	1700	3200	9.4	12.5	FA 04	5	3200	3200	9.4	12.4
1.1	BN 80B	2	2800	3.8	●	76.4	76.2	75.0	0.81	2.57	4.8	2.8	2.4	9.0	9.5	FD 04	10	1500	3000	10.6	13.4	FA 04	10	3000	3000	10.6	13.3
1.5	BN 80C	2	2800	5.1	●	79.1	79.5	77.2	0.81	3.4	4.9	2.7	2.4	11.4	11.3	FD 04	15	1300	2600	13.0	15.2	FA 04	15	2600	2600	13.0	15.1
1.5	BN 90SA	2	2870	5.0	●	82.0	81.5	78.1	0.80	3.4	5.9	2.7	2.6	12.5	12.3	FD 14	15	900	2200	14.1	16.5	FA 14	15	2200	2200	14.1	16.4
1.85	BN 90SB	2	2880	6.1	●	82.5	82.0	75.4	0.80	4.0	6.2	2.9	2.6	16.7	14	FD 14	15	900	2200	18.3	18.2	FA 14	15	2200	2200	18.3	18.1
2.2	BN 90L	2	2880	7.3	●	82.7	82.1	80.8	0.80	4.8	6.3	2.9	2.7	16.7	14	FD 05	26	900	2200	21	20	FA 05	26	2200	2200	21	20.7
3	BN 100L	2	2860	10.0	●	81.5	81.3	77.4	0.79	6.7	5.6	2.6	2.2	31	20	FD 15	26	700	1600	35	26	FA 15	26	1600	1600	35	27
4	BN 100LB	2	2870	13.3	●	83.1	83.0	77.8	0.80	8.7	5.8	2.7	2.5	39	23	FD 15	40	450	900	43	29	FA 15	40	1000	1000	43	30
4	BN 112M	2	2900	13.2	●	85.5	84.5	83.0	0.82	8.2	6.9	3.0	2.9	57	28	FD 06S	40	—	950	66	39	FA 06S	40	950	950	66	40
5.5	BN 132SA	2	2890	18.2	●	84.7	84.5	81.2	0.84	11.2	5.9	2.6	2.2	101	35	FD 06	50	—	600	112	48	FA 06	50	600	600	112	49
7.5	BN 132SB	2	2900	25	●	86.5	86.3	84.4	0.85	14.7	6.4	2.6	2.2	145	42	FD 06	50	—	550	154	55	FA 06	50	550	550	154	56
9.2	BN 132M	2	2930	30	●	87.0	86.5	83.6	0.86	17.7	6.7	2.8	2.3	178	53	FD 56	75	—	430	189	66	FA 06	75	430	430	189	67
11	BN 160MR	2	2920	36	●	87.6	87.0	86.0	0.88	20.6	6.9	2.9	2.5	210	65												
15	BN 160MB	2	2930	49	●	89.6	89.4	88.0	0.86	28.1	7.1	2.6	2.3	340	84												
18.5	BN 160L	2	2930	60	●	90.4	90.1	89.0	0.86	34	7.6	2.7	2.3	420	97												
22	BN 180M	2	2930	72	●	89.9	89.7	89.5	0.88	40	7.8	2.6	2.4	490	109												
30	BN 200LA	2	2930	98	●	90.7	90.1	87.6	0.89	54	7.8	2.7	2.9	770	140												



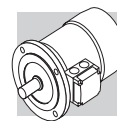

○ = n.a. ● = IE1



4P

1500 min⁻¹ - S1

50 Hz

P _n kW		n min ⁻¹	M _n Nm	IE1	η (100%) %	η (75%) %	η (50%) %	cosφ	In 400V A	Is In	Ms Mn	Ma Mn	J _m x 10 ⁻⁴ kgm ²	IM B5  Kg	d.c. brake						a.c. brake					
															FD			FA			FD			FA		
															Mod	Mb Nm	Z ₀ 1/h	NB	SB	IM B5  Kg	Mod	Mb Nm	Z ₀ 1/h	J _m x 10 ⁻⁴ kgm ²	IM B5  Kg	
0.06	BN 56A	4	1340	0.43	46.8	44.2	41.3	0.65	0.28	2.6	2.3	2.0	1.5	3.1	FD 02	1.75	10000	13000	2.6	5.2	FA 02	1.75	13000	2.6	5.0	
0.09	BN 56B	4	1350	0.64	51.7	47.6	42.9	0.60	0.42	2.6	2.5	2.4	1.5	3.1	FD 02	3.5	10000	13000	3.0	5.6	FA 02	3.5	13000	3.0	5.4	
0.12	BN 63A	4	1350	0.85	59.8	56.2	47.0	0.62	0.47	2.6	1.9	1.8	2.0	3.5	FD 02	3.5	7800	10000	3.9	6.8	FA 02	3.5	10000	3.9	6.6	
0.18	BN 63B	4	1320	1.30	54.8	52.9	52.5	0.67	0.71	2.6	2.2	2.0	2.3	3.9	FD 03	5	6000	9400	8.0	8.6	FA 03	5	9400	8.0	8.3	
0.25	BN 63C	4	1340	1.78	65.3	65.0	57.9	0.69	0.80	2.7	2.1	1.9	3.3	5.1	FD 53	7.5	4300	8700	10.2	10.0	FA 03	7.5	8700	10.2	9.7	
0.25	BN 71A	4	1380	1.73	63.7	62.2	59.1	0.73	0.78	3.3	1.9	1.7	5.8	5.1	FD 03	3.5	7700	11000	6.9	7.8	FA 03	3.5	11000	6.9	7.5	
0.37	BN 71B	4	1370	2.6	66.8	66.7	63.0	0.76	1.05	3.7	2.0	1.9	6.9	5.9	FD 03	5	6000	9400	8.0	8.6	FA 03	5	9400	8.0	8.3	
0.55	BN 71C	4	1380	3.8	69.0	68.9	68.8	0.74	1.55	4.1	2.3	2.3	9.1	7.3	FD 04	10	4100	8000	16.6	12.1	FA 04	10	8000	16.6	12.0	
0.55	BN 80A	4	1390	3.8	72.0	71.3	69.7	0.77	1.43	4.1	2.3	2.0	15	8.2	FD 04	15	4100	7800	22	13.8	FA 04	15	7800	22	13.7	
0.75	BN 80B	4	1400	5.1	75.0	74.5	69.3	0.78	1.85	4.9	2.7	2.5	20	9.9	FD 04	15	2600	5300	27	15.2	FA 04	15	5300	27	15.1	
1.1	BN 80C	4	1400	7.5	75.5	76.2	70.4	0.78	2.7	5.1	2.8	2.5	25	11.3	FD 14	15	4800	8000	23	16.4	FA 14	15	8000	23	16.3	
1.1	BN 90S	4	1390	7.6	76.5	76.2	72.2	0.77	2.70	4.6	2.6	2.2	21	12.2	FD 05	26	3400	6000	32	19.6	FA 05	26	6000	32	20.3	
1.5	BN 90LA	4	1410	10.2	78.7	78.5	74.9	0.77	3.6	5.3	2.8	2.4	28	13.6	FD 05	26	3200	5900	34	21.1	FA 05	26	5900	34	21.8	
1.85	BN 90LB	4	1390	12.7	78.6	78.9	77.2	0.79	4.3	5.1	2.8	2.6	30	15.1	FD 15	40	2600	4700	44	25	FA 15	40	4700	44	25	
2.2	BN 100LA	4	1410	14.9	81.1	81.4	79.9	0.75	5.2	4.5	2.2	2.0	40	18	FD 15	40	2400	4400	58	28	FA 15	40	4400	58	29	
3	BN 100LB	4	1410	20	82.6	83.8	83.7	0.77	6.8	5.0	2.3	2.2	54	22	FD 06S	60	—	1400	107	40	FA 06S	60	2100	107	42	
4	BN 112M	4	1430	27	84.4	84.2	81.6	0.81	8.4	5.6	2.7	2.5	98	30	FD 56	75	—	1050	223	57	FA 06	75	1200	223	58	
5.5	BN 132S	4	1440	36	84.7	84.8	82.5	0.81	11.6	5.5	2.3	2.2	213	44	FD 06	100	—	950	280	66	FA 07	100	1000	280	71	
7.5	BN 132MA	4	1440	50	86.0	86.3	85.3	0.81	15.5	5.7	2.5	2.4	270	53	FD 07	150	—	900	342	75	FA 07	150	900	342	77	
9.2	BN 132MB	4	1440	61	88.4	88.6	87.5	0.81	18.8	5.9	2.7	2.5	319	59	FD 07	150	—	850	382	86	FA 07	150	850	382	88	
11	BN 160MR	4	1440	73	87.6	87.8	86.0	0.81	22.4	6.0	2.7	2.5	360	70	FD 08	200	—	750	725	129	FA 08	200	750	710	128	
15	BN 160L	4	1460	98	88.7	88.5	88.4	0.81	30	6.0	2.3	2.1	650	99	FD 08	250	—	700	865	145	FA 08	250	700	865	144	
18.5	BN 180M	4	1460	121	89.3	89.5	89.2	0.81	37	6.2	2.6	2.5	790	115	FD 09	300	—	400	1450	175	FA 09	300	400	1450	175	
22	BN 180L	4	1460	144	89.9	90.0	90.0	0.80	44	6.4	2.5	2.5	1250	135	FD 09	400	—	300	1850	197	FA 09	400	300	1850	197	
30	BN 200L	4	1460	196	91.4	91.7	91.0	0.80	59	7.1	2.7	2.8	1650	157	FD 09	400	—	300	1850	197	FA 09	400	300	1850	197	

○ = n.a. ● = IE1

BN

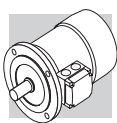

6P		1000 min ⁻¹ - S1																50 Hz							
		d.c. brake																a.c. brake							
		FD																FA							
P _n		n	M _n	IE1	η (100%)	η (75%)	η (50%)	cosφ	In	Is	Ms	M _a	M _n	J _m	IM B5	Mod	Mb	Z ₀	J _m	IM B5	Mod	Mb	Z ₀	J _m	IM B5
kW		min ⁻¹	Nm		%	%	%		A					x 10 ⁻⁴ kgm ²	kg		Nm	1/h	x 10 ⁻⁴ kgm ²	kg		Nm	1/h	x 10 ⁻⁴ kgm ²	kg
0.09	BN 63A	6	0.98	○	41.0	41.0	32.9	0.53	0.60	2.1	2.1	1.8	3.4	4.6	FD 02	3.5	9000	14000	4.0	6.3	FA 02	3.5	14000	4.0	6.1
0.12	BN 63B	6	1.32	○	45.0	44.0	41.8	0.60	0.64	2.1	1.9	1.7	3.7	4.9	FD 02	3.5	9000	14000	4.3	6.6	FA 02	3.5	14000	4.3	6.4
0.18	BN 71A	6	1.91	○	55.0	55.5	51.0	0.69	0.68	2.6	1.9	1.7	8.4	5.5	FD 03	5	8100	13500	9.5	8.2	FA 03	5.0	13500	9.5	7.9
0.25	BN 71B	6	2.70	○	62.0	58.5	51.4	0.71	0.82	2.6	1.9	1.7	10.9	6.7	FD 03	5	7800	13000	12	9.4	FA 03	5.0	13000	12	9.1
0.37	BN 71C	6	3.9	○	66.0	60.0	53.3	0.69	1.17	3.0	2.4	2.0	12.9	7.7	FD 53	7.5	5100	9500	14	10.4	FA 03	7.5	9500	14	10.1
0.37	BN 80A	6	3.9	○	68.0	67.4	63.3	0.68	1.15	3.2	2.2	2.0	21	9.9	FD 04	10	5200	8500	23	13.8	FA 04	10	8500	23	13.7
0.55	BN 80B	6	5.7	○	70.0	69.8	64.3	0.68	1.67	3.9	2.6	2.2	25	11.3	FD 04	15	4800	7200	27	15.2	FA 04	15	7200	27	15.1
0.75	BN 80C	6	7.8	●	70.0	70.0	64.4	0.65	2.38	3.8	2.5	2.2	28	12.2	FD 04	15	3400	6400	30	16.1	FA 04	15	6400	30	16.0
0.75	BN 90S	6	7.8	●	70.0	69.0	64.2	0.68	2.27	3.8	2.4	2.2	26	12.6	FD 14	15	3400	6500	28	16.8	FA 14	15	6500	28	16.7
1.1	BN 90L	6	11.4	●	72.9	72.6	69.1	0.69	3.2	3.9	2.3	2.0	33	15	FD 05	26	2700	5000	37	21	FA 05	26	5000	37	22
1.5	BN 100LA	6	15.2	●	75.2	74.2	70.3	0.72	4.0	4.1	2.1	2.0	82	22	FD 15	40	1900	4100	86	28	FA 15	40	4100	86	29
1.85	BN 100LB	6	19.0	●	76.6	72.8	62.6	0.73	4.8	4.6	2.1	2.0	95	24	FD 15	40	1700	3600	99	30	FA 15	40	3600	99	31
2.2	BN 112M	6	22	●	78.5	79.0	76.5	0.73	5.5	4.8	2.2	2.0	168	32	FD 06S	60	—	2100	177	42	FA 06S	60	2100	177	44
3	BN 132S	6	30	●	79.7	77.0	75.1	0.76	7.1	5.1	1.9	1.8	216	36	FD 56	75	—	1400	226	49	FA 06	75	1400	226	50
4	BN 132MA	6	40	●	81.4	81.5	79.5	0.77	9.2	5.5	2.0	1.8	295	45	FD 06	100	—	1200	305	58	FA 07	100	1200	318	63
5.5	BN 132MB	6	56	●	83.1	80.9	79.1	0.78	12.2	6.1	2.1	1.9	383	56	FD 07	150	—	1050	406	72	FA 07	150	1050	406	74
7.5	BN 160M	6	75	●	85.0	85.0	84.8	0.81	15.7	5.9	2.2	2.0	740	83	FD 08	170	—	900	815	112	FA 08	170	900	815	113
11	BN 160L	6	109	●	86.4	86.5	85.9	0.81	22.7	6.6	2.5	2.3	970	103	FD 08	200	—	800	1045	133	FA 08	200	800	1045	133
15	BN 180L	6	148	●	87.7	88.0	87.3	0.82	30	6.2	2.0	2.4	1550	130	FD 09	300	—	600	1750	170	—	—	600	1750	170
18.5	BN 200LA	6	184	●	88.6	88.0	87.3	0.81	37	5.9	2.0	2.3	1700	145	FD 09	400	—	450	1900	185	—	—	450	1900	185



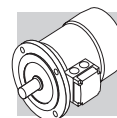

○ = n.a. ● = IE1



8P

750 min⁻¹ - S1

50 Hz

P _n kW		n min ⁻¹	M _n Nm	η %	cosφ	I _n 400V A	I _s I _n	M _s M _n	M _a M _n	J _m x 10 ⁻⁴ kgm ²	IM B5 	d.c. brake							a.c. brake						
												FD			FA				FD			FA			
												Mod	Mb Nm	Z ₀ 1/h	NB	SB	J _m x 10 ⁻⁴ kgm ²	IM B5 	Mod	Mb Nm	Z ₀ 1/h	J _m x 10 ⁻⁴ kgm ²	IM B5 		
0.09	BN 71A	8	1.26	47	0.59	0.47	2.3	2.4	2.3	10.9	6.7	FD 03	3.5	9000	16000	12.0	9.4	FA 03	3.5	16000	12.0	9.1			
0.12	BN 71B	8	1.69	51	0.59	0.58	2.1	2.3	2.2	12.9	7.7	FD 03	5.0	9000	16000	14.0	10.4	FA 03	5.0	16000	14.0	10.1			
0.18	BN 80A	8	2.49	51	0.60	0.85	2.4	2.2	2.2	15	8.2	FD 04	5.0	6500	11000	16.6	12.1	FA 04	5.0	11000	16.6	12.0			
0.25	BN 80B	8	3.51	54	0.63	1.06	2.4	2.0	1.9	20	9.9	FD 04	10.0	6000	10000	22	13.8	FA 04	10.0	10000	23	13.7			
0.37	BN 90S	8	5.2	58	0.60	1.53	2.6	2.3	2.1	26	12.6	FD 14	15.0	4800	7500	28	16.8	FA 14	15.0	7500	28	16.7			
0.55	BN 90L	8	7.8	62	0.60	2.13	2.6	2.2	2.0	33	15	FD 05	26	4000	6400	37	21	FA 05	26	6400	37	22			
0.75	BN 100LA	8	10.2	68	0.63	2.53	3.4	1.9	1.7	82	22	FD 15	26	2800	4800	86	28	FA 15	26	4800	86	29			
1.1	BN 100LB	8	15.0	68	0.64	3.65	3.2	1.7	1.7	95	24	FD 15	40	2500	4000	99	30	FA 15	40	4000	99	31			
1.5	BN 112M	8	20.2	71	0.66	4.6	3.7	1.8	1.9	168	32	FD 06S	60	—	3000	177	42	FA 06S	60	3000	177	44			
2.2	BN 132S	8	29.6	75	0.66	6.4	3.8	1.8	2.0	295	45	FD 06	75	—	2300	305	58	FA 06	75	2300	305	56			
3	BN 132MA	8	40.4	76	0.69	8.3	3.9	1.6	1.8	370	53	FD 06	100	—	1900	394	69	FA 07	100	1900	406	74			

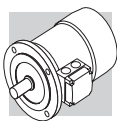

BN

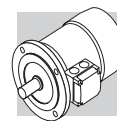

2/4P		3000/1500 min ⁻¹ - S1														50 Hz													
		d.c. brake														a.c. brake													
		FD							FA							FD							FA						
P _n		n	M _n	η	cosφ	I _n	I _s	I _n	I _s	M _a	M _n	J _m	IM B5	Mod	Mb	Z ₀	1/h	Sb	J _m	IM B5	Mod	Mb	Z ₀	1/h	J _m	IM B5			
kW		min ⁻¹	Nm	%		A	A	A	A	Nm	Nm	kgm ²	kg		Nm				kgm ²	kg		Nm			kgm ²	kg			
0.20	BN 63B	2	0.71	55	0.82	0.64	3.5	2.1	1.9	2.9	4.4	2.9	4.4	FD 02	3.5	2200	2600	5100	3.5	6.1	FA 02	3.5	2600	5100	3.5	5.9			
0.15		4	1.350	49	0.67	0.66	2.6	1.8	1.7																				
0.28	BN 71A	2	0.99	56	0.82	0.88	2.9	1.9	1.7	4.7	4.4	4.7	4.4	FD 03	3.5	2100	2400	4800	3.5	7.1	FA 03	3.5	2400	4800	3.5	6.8			
0.20		4	1.370	59	0.72	0.88	3.1	1.8	1.7																				
0.37	BN 71B	2	1.29	56	0.82	1.16	3.5	1.8	1.8	5.8	5.1	5.8	5.1	FD 03	5.0	1400	2100	4200	5.0	7.8	FA 03	5.0	2100	4200	5.0	7.5			
0.25		4	1.390	60	0.73	0.82	3.3	2.0	1.9																				
0.45	BN 71C	2	1.55	63	0.85	1.21	3.8	1.8	1.8	6.9	5.9	6.9	5.9	FD 03	5.0	1400	2100	4200	5.0	8.6	FA 03	5.0	2100	4200	5.0	8.3			
0.30		4	1.400	63	0.73	0.94	3.6	2.0	1.9																				
0.55	BN 80A	2	2.800	63	0.85	1.48	3.9	1.7	1.7	15	8.2	15	8.2	FD 04	5.0	1600	2300	4000	5.0	12.1	FA 04	5.0	2300	4000	5.0	12.0			
0.37		4	1.400	67	0.79	1.01	4.1	1.8	1.9																				
0.75	BN 80B	2	2.780	65	0.85	1.96	3.8	1.9	1.8	20	9.9	20	9.9	FD 04	10	1400	1600	3600	10	13.8	FA 04	10	1600	3600	10	13.7			
0.55		4	1.400	68	0.81	1.44	3.9	1.7	1.7																				
1.1	BN 90S	2	2.790	71	0.82	2.73	4.7	2.3	2.0	21	12.2	21	12.2	FD 14	10	1500	1600	2000	10	16.4	FA 14	10	1600	2000	10	16.3			
0.75		4	1.390	66	0.79	2.08	4.6	2.4	2.2																				
1.5	BN 90L	2	2.780	70	0.85	3.64	4.5	2.4	2.1	28	14.0	28	14.0	FD 05	26	1050	1200	2000	26	20	FA 05	26	1200	2000	26	21			
1.1		4	1.390	73	0.81	2.69	4.7	2.5	2.2																				
2.2	BN 100LA	2	2.800	75	0.85	5.2	4.5	2.0	1.9	40	18.3	40	18.3	FD 15	26	600	900	2100	26	25	FA 15	26	900	2100	26	25			
1.5		4	1.410	73	0.79	3.8	4.7	2.0	2.0																				
3.5	BN 100LB	2	2.850	80	0.84	7.5	5.4	2.2	2.1	61	25	61	25	FD 15	40	500	900	2100	40	31	FA 15	40	900	2100	40	32			
2.5		4	1.420	82	0.80	5.5	5.2	2.2	2.2																				
4	BN 112M	2	2.880	79	0.83	8.8	6.1	2.4	2.0	98	30	98	30	FD 06S	60	—	700	107	60	40	FA 06S	60	700	107	60	42			
3.3		4	1.420	80	0.80	7.4	5.1	2.1	2.0																				
5.5	BN 132S	2	2.890	80	0.87	11.4	5.9	2.4	2.0	213	44	213	44	FD 56	75	—	350	223	75	57	FA 06	75	350	223	75	58			
4.4		4	1.440	82	0.84	9.2	5.3	2.2	2.0																				
7.5	BN 132MA	2	2.900	82	0.87	15.2	6.5	2.4	2.0	270	53	270	53	FD 06	100	—	350	280	100	66	FA 07	100	350	280	100	71			
6		4	1.430	84	0.85	12.1	5.8	2.3	2.1																				
9.2	BN 132MB	2	2.920	83	0.86	18.6	6.0	2.6	2.2	319	59	319	59	FD 07	150	—	300	342	150	75	FA 07	150	300	342	150	77			
7.3		4	1.440	85	0.85	14.6	5.5	2.3	2.1																				





2/6P **3000/1000 min⁻¹ - S3 60/40%** **50 Hz**

P _n kW		n min ⁻¹	M _h Nm	η %	cosφ	I _n 400V A	I _s I _n	M _s M _n	M _a M _n	J _m x 10 ⁻⁴ kgm ²	IM B5 	Mod	Mb Nm	d.c. brake			a.c. brake					
														FD			FA					
														Mod	Mb Nm	Z ₀ 1/h	NB	SB	J _m x 10 ⁻⁴ kgm ²	IM B5 	Mb	Mmod
0.25	BN 71A	2850	0.84	60	0.82	0.73	4.3	1.9	1.8	6.9	5.9	FD 03	1.75	1500	1700	8.0	8.6	FA 03	2.5	1700	8.0	8.3
0.08	6	910	0.84	43	0.70	0.38	2.1	1.4	1.5					10000	13000					13000		
0.37	BN 71B	2880	1.23	62	0.80	1.08	4.4	1.9	1.8	9.1	7.3	FD 03	3.5	1000	1300	10.2	10.0	FA 03	3.5	1300	10.2	9.7
0.12	6	900	1.27	44	0.73	0.54	2.4	1.4	1.5					9000	11000					11000		
0.55	BN 80A	2800	1.88	63	0.86	1.47	4.5	1.9	1.7	20	9.9	FD 04	5.0	1500	1800	22	13.8	FA 04	5.0	1800	22	13.7
0.18	6	930	1.85	52	0.65	0.77	3.3	2.0	1.9					4100	6300					6300		
0.75	BN 80B	2800	2.6	66	0.87	1.89	4.3	1.8	1.6	25	11.3	FD 04	5.0	1700	1900	27	15.2	FA 04	5.0	1900	27	15.1
0.25	6	930	2.6	54	0.67	1.00	3.2	1.7	1.8					3800	6000					6000		
1.10	BN 90L	2860	3.7	67	0.84	2.82	4.7	2.1	1.9	28	14.0	FD 05	13	1400	1600	32	20	FA 05	13	1600	32	21
0.37	6	920	3.8	59	0.71	1.27	3.3	1.6	1.6					3400	5200					5200		
1.5	BN 100LA	2880	5	73	0.84	3.53	5.1	1.9	2.0	40	18.3	FD 15	13	1000	1200	44	24	FA 15	13	1200	44	25
0.55	6	940	5.6	64	0.67	1.85	3.5	1.7	1.8					2900	4000					4000		
2.2	BN 100LB	2900	7.2	77	0.85	4.9	5.9	2.0	2.0	61	25	FD 15	26	700	900	65	31	FA 15	26	900	65	32
0.75	6	950	7.5	67	0.64	2.5	3.3	1.9	1.8					2100	3000					3000		
3	BN 112M	2900	9.9	78	0.87	6.4	6.3	2.0	2.1	98	30	FD 06S	40	—	1000	107	40	FA 06S	40	1000	107	32
1.1	6	950	11.1	72	0.64	3.4	3.9	1.8	1.8					—	2600					2600		
4.5	BN 132S	2910	14.8	78	0.84	9.9	5.8	1.9	1.8	213	44	FD 56	37	—	500	223	57	FA 06	37	500	223	58
1.5	6	960	14.9	74	0.67	4.4	4.2	1.9	2.0					—	2100					2100		
5.5	BN 132M	2920	18.0	78	0.87	11.7	6.2	2.1	1.9	270	53	FD 56	50	—	400	280	66	FA 06	50	400	280	67
2.2	6	960	22	77	0.71	5.8	4.3	2.1	2.0					—	1900					1900		

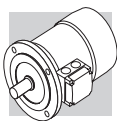



2/8P **3000/750 min⁻¹ - S3 60/40%** **50 Hz**



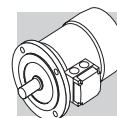

P _n kW		n min ⁻¹	M _n Nm	η %	cosφ	I _n 400V A	I _s I _n	M _s M _n	M _a M _n	J _m x 10 ⁻⁴ kgm ²	IM B5 	d.c. brake						a.c. brake						
												FD			FA			FD			FA			
												Mod	Mb Nm	Z ₀ 1/h	NB	SB	Mod	Mb Nm	Z ₀ 1/h	J _m x 10 ⁻⁴ kgm ²	IM B5 	Mod	Mb Nm	Z ₀ 1/h
0.25	BN 71A	2	2790	0.86	61	0.87	3.9	1.8	1.9	10.9	6.7	FD 03	1.75	1300	1400	1400	1400	12	9.4	FA 03	2.5	1400	12	9.1
0.06		8	680	0.84	31	0.61	2.0	1.8	1.9					10000	13000	13000	13000					13000		
0.37	BN 71B	2	2800	1.26	63	0.86	3.9	1.8	1.9	12.9	7.7	FD 03	3.5	1200	1300	1300	1300	14	10.4	FA 03	3.5	1300	14	10.1
0.09		8	670	1.28	34	0.75	1.8	1.4	1.5					9500	13000	13000	13000					13000		
0.55	BN 80A	2	2830	1.86	66	0.86	4.4	2.1	2.0	20	9.9	FD 04	5.0	1500	1800	1800	1800	22	13.8	FA 04	5.0	1800	22	13.7
0.13		8	690	1.80	41	0.64	2.3	1.6	1.7					5600	8000	8000	8000					8000		
0.75	BN 80B	2	2800	2.6	68	0.88	4.6	2.1	2.0	25	11.3	FD 04	10	1700	1900	1900	1900	27	15.2	FA 04	10	1900	27	15.1
0.18		8	690	2.5	43	0.66	2.3	1.6	1.7					4800	7300	7300	7300					7300		
1.10	BN 90L	2	2830	3.7	63	0.84	4.5	2.1	1.9	28	14.0	FD 05	13	1400	1600	1600	1600	32	20	FA 05	13	1600	32	21
0.28		8	690	3.9	48	0.63	1.34	1.8	1.9					3400	5100	5100	5100					5100		
1.5	BN 100LA	2	2880	5.0	69	0.85	4.7	1.9	1.8	40	18.3	FD 15	13	1000	1200	1200	1200	44	25	FA 15	13	1200	44	25
0.37		8	690	5.1	46	0.63	1.84	1.6	1.6					3300	5000	5000	5000					5000		
2.4	BN 100LB	2	2900	7.9	75	0.82	5.6	2.1	2.0	61	25	FD 15	26	550	700	700	700	65	31	FA 15	26	700	65	32
0.55		8	700	7.5	54	0.58	2.6	1.8	1.8					2000	3500	3500	3500					3500		
3	BN 112M	2	2900	9.9	76	0.87	6.3	2.1	1.9	98	30	FD 06S	40	—	900	900	900	107	40	FA 06S	40	900	107	42
0.75		8	690	10.4	60	0.65	2.8	1.6	1.6					—	2900	2900	2900					2900		
4	BN 132S	2	2870	13.3	73	0.84	9.4	2.3	2.4	213	44	FD 56	37	—	500	500	500	223	57	FA 06	37	500	223	58
1		8	690	13.8	66	0.62	3.5	1.9	1.8					—	3500	3500	3500					3500		
5.5	BN 132M	2	2870	18.3	75	0.84	12.6	2.4	2.5	270	53	FD 06	50	—	400	400	400	280	66	FA 06	50	400	280	67
1.5		8	690	21	68	0.63	5.1	1.9	1.9					—	2400	2400	2400					2400		



2/12P

3000/500 min⁻¹ - S3 60/40%

50 Hz

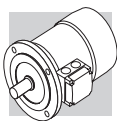

P _n kW		n min ⁻¹	M _n Nm	η %	cosφ	I _n 400V A	I _s I _n	M _s M _n	M _a M _n	J _m x 10 ⁻⁴ kgm ²	IM B5 	Mod	Mb Nm	d.c. brake			a.c. brake					
														FD			FA					
														NB	Z ₀ 1/h	J _m x 10 ⁻⁴ kgm ²	IM B5 	Mod	Mb Nm	Z ₀ 1/h	J _m x 10 ⁻⁴ kgm ²	IM B5 
0.55	BN 80B	2 2820	1.86	64	0.89	1.39	4.2	1.6	1.7	25	11.3	FD 04	5.0	1000	1300	27	15.2	FA 04	5.0	1300	27	15.1
0.09		12 430	2.0	30	0.63	0.69	1.8	1.9	1.8		8000	12000		8000	12000							
0.75	BN 90L	2 2790	2.6	56	0.89	2.17	4.2	1.8	1.7	26	12.6	FD 05	13	1000	1150	30	18.6	FA 05	13	1150	30	19.3
0.12		12 430	2.7	26	0.63	1.06	1.7	1.4	1.6		4600	6300		4600	6300							
1.10	BN 100LA	2 2850	3.7	65	0.85	2.87	4.5	1.6	1.8	40	18.3	FD 15	13	700	900	44	25	FA 15	13	900	44	25
0.18		12 430	4.0	26	0.54	1.85	1.5	1.3	1.5		4000	6000		4000	6000							
1.5	BN 100LB	2 2900	4.9	67	0.86	3.76	5.6	1.9	1.9	54	22	FD 15	13	700	900	58	28	FA 15	13	900	58	29
0.25		12 440	5.4	36	0.46	2.18	1.8	1.7	1.8		3800	5000		3800	5000							
2	BN 112M	2 2900	6.6	74	0.88	4.43	6.5	2.1	2.0	98	30	FD 06S	20	—	800	107	40	FA 06S	20	800	107	42
0.3		12 460	6.2	46	0.43	2.19	2.0	2.1	2.0		—	3400		—	3400							
3	BN 132S	2 2920	9.8	74	0.87	6.7	6.8	2.3	1.9	213	44	FD 56	37	—	450	223	57	FA 06	37	450	223	58
0.5		12 470	10.2	51	0.43	3.3	2.0	1.7	1.6		—	3000		—	3000							
4	BN 132M	2 2920	13.1	75	0.89	8.6	5.9	2.4	2.3	270	53	FD 56	37	—	400	280	66	FA 06	37	400	280	67
0.7		12 460	14.5	53	0.44	4.3	1.9	1.7	1.6		—	2800		—	2800							



4/6P

1500/1000 min⁻¹ - S1

50 Hz

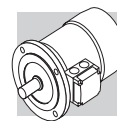

P _n kW		n min ⁻¹	M _n Nm	η %	cosφ	I _n 400V A	I _s I _n	M _s M _n	M _a M _n	J _m x 10 ⁻⁴ kgm ²	IM B5 	d.c. brake						a.c. brake					
												FD			FA			FD			FA		
												Mod	Mb Nm	Z ₀ 1/h	NB	SB	Mod	Mb Nm	Z ₀ 1/h	J _m x 10 ⁻⁴ kgm ²	IM B5 	Mod	Mb Nm
0.22	BN 71B	4	1410	1.5	0.74	0.67	3.9	1.8	1.9	9.1	7.3	FD 03	3.5	2500	3500	10.2	10.0	FA 03	3.5	3500	10.2	9.7	
0.13		6	920	1.4	0.67	0.65	2.3	1.6	1.7				5000	9000						9000			
0.30	BN 80A	4	1410	2.0	0.82	0.87	3.5	1.3	1.5	15	8.2	FD 04	5.0	2500	3100	16.6	12.1	FA 04	5.0	3100	16.6	12.0	
0.20		6	930	2.1	0.66	0.81	3.2	1.9	2.0				4000	6000						6000			
0.40	BN 80B	4	1430	2.7	0.75	1.22	3.9	1.8	1.8	20	9.9	FD 04	10	1800	2300	22	13.8	FA 04	10	2300	22	13.7	
0.26		6	930	2.7	0.70	0.97	2.7	1.5	1.6				3600	5500						5500			
0.55	BN 90S	4	1420	3.7	0.78	1.45	4.5	2.0	1.9	21	12.2	FD 14	10	1500	2100	23	16.1	FA 14	10	2100	23	16.3	
0.33		6	930	3.4	0.70	1.10	3.7	2.3	2.0				2500	4100						4100			
0.75	BN 90L	4	1420	5.0	0.78	1.88	4.3	1.9	1.8	28	14	FD 05	13	1400	2000	32	20	FA 05	13	2000	32	21	
0.45		6	920	4.7	0.71	1.39	3.3	2.0	1.9				2300	3600						3600			
1.1	BN 100LA	4	1450	7.2	0.79	2.72	5.0	1.7	1.9	82	22	FD 15	26	1400	2000	86	28	FA 15	26	2000	86	29	
0.8		6	950	8.0	0.69	2.57	4.1	1.9	2.1				2100	3300						3300			
1.5	BN 100LB	4	1450	9.9	0.79	3.65	5.1	1.7	1.9	95	25	FD 15	26	1300	1800	99	31	FA 15	26	1800	99	32	
1.1		6	950	11.1	0.68	3.24	4.3	2.0	2.1				2000	3000						3000			
2.3	BN 112M	4	1450	15.2	0.78	5.7	5.2	1.8	1.9	168	32	FD 06S	40	—	1600	177	42	FA 06S	40	1600	177	44	
1.5		6	960	14.9	0.72	4.1	4.9	2.0	2.0				—	2400						2400			
3.1	BN 132S	4	1460	20	0.83	6.5	5.9	2.1	2.0	213	44	FD 06	37	—	1200	223	57	FA 06	37	1200	223	58	
2		6	960	20	0.75	4.9	4.5	2.1	2.1				—	1900						1900			
4.2	BN 132MA	4	1460	27	0.82	8.8	5.9	2.1	2.2	270	53	FD 06	50	—	900	280	66	FA 06	50	900	280	67	
2.6		6	960	26	0.72	6.6	4.3	2.0	2.0				—	1500						1500			



4/8P

1500/750 min⁻¹ - S1

50 Hz

P _n kW		n min ⁻¹	M _n Nm	η %	cosφ	I _n 400V A	I _s I _n	M _s M _n	M _a M _n	J _m x 10 ⁻⁴ kgm ²	IM B5 	d.c. brake					a.c. brake											
												FD					FA											
												Mod	Mb Nm	Z ₀ 1/h	NB	SB	Mod	Mb Nm	Z ₀ 1/h	J _m x 10 ⁻⁴ kgm ²	IM B5 							
0.37	BN 80A	4	1400	2.5	63	0.82	1.03	3.3	1.4	1.4	15	8.2	FD 04	10	2300	3500	4500	2300	3500	16.6	12.1	FA 04	10	3500	7000	16.6	12.0	
0.18		8	690	2.5	44	0.60	0.98	2.2	1.5	1.6																		
0.55	BN 80B	4	1390	3.8	65	0.86	1.42	3.8	1.7	1.6	20	9.9	FD 04	10	2200	2900	4200	2200	2900	22	13.8	FA 04	10	2900	6500	22	13.7	
0.30		8	670	4.3	49	0.65	1.36	2.3	1.7	1.8																		
0.65	BN 90S	4	1390	4.5	73	0.85	1.51	4.0	1.9	1.9	28	13.6	FD 14	15	2300	2800	3500	2300	2800	30	17.8	FA 14	15	2800	6000	30	17.7	
0.35		8	690	4.8	49	0.57	1.81	2.5	2.1	2.2																		
0.9	BN 90L	4	1370	6.3	73	0.87	2.05	3.8	1.8	1.8	30	15.1	FD 05	26	1700	2100	2500	1700	2100	34	21	FA 05	26	2100	4200	34	22	
0.5		8	670	7.1	57	0.62	2.04	2.4	2.1	2.0																		
1.30	BN 100LA	4	1420	8.7	72	0.83	3.14	4.3	1.7	1.8	82	22	FD 15	40	1300	1700	2000	1300	1700	86	28	FA 15	40	1700	3400	86	29	
0.70		8	700	9.6	58	0.64	2.72	2.8	1.8	1.8																		
1.8	BN 100LB	4	1420	12.1	69	0.87	4.3	4.2	1.6	1.7	95	25	FD 15	40	1200	1700	1600	1200	1700	99	31	FA 15	40	1700	2600	99	32	
0.9		8	700	12.3	62	0.63	3.3	3.2	1.7	1.8																		
2.2	BN 112M	4	1440	14.6	77	0.85	4.9	5.3	1.8	1.8	168	32	FD 06S	60	—	1200	—	—	1200	177	42	FA 06S	60	1200	2000	177	43	
1.2		8	710	16.1	70	0.63	3.9	3.3	1.9	1.8																		
3.6	BN 132S	4	1440	24	80	0.82	7.9	6.5	2.1	1.9	295	45	FD 56	75	—	1000	—	—	1000	305	58	FA 06	75	1000	1400	305	59	
1.8		8	720	24	72	0.55	6.6	4.6	1.9	2.0																		
4.6	BN 132M	4	1450	30	81	0.83	9.9	6.5	2.2	1.9	383	56	FD 06	100	—	1000	—	—	1000	393	69	FA 07	100	1000	1300	406	74	
2.3		8	720	31	73	0.54	8.4	4.4	2.3	2.0																		

BN

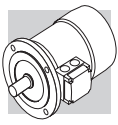

18 MOTORS DIMENSIONS BN

BN - IM B3

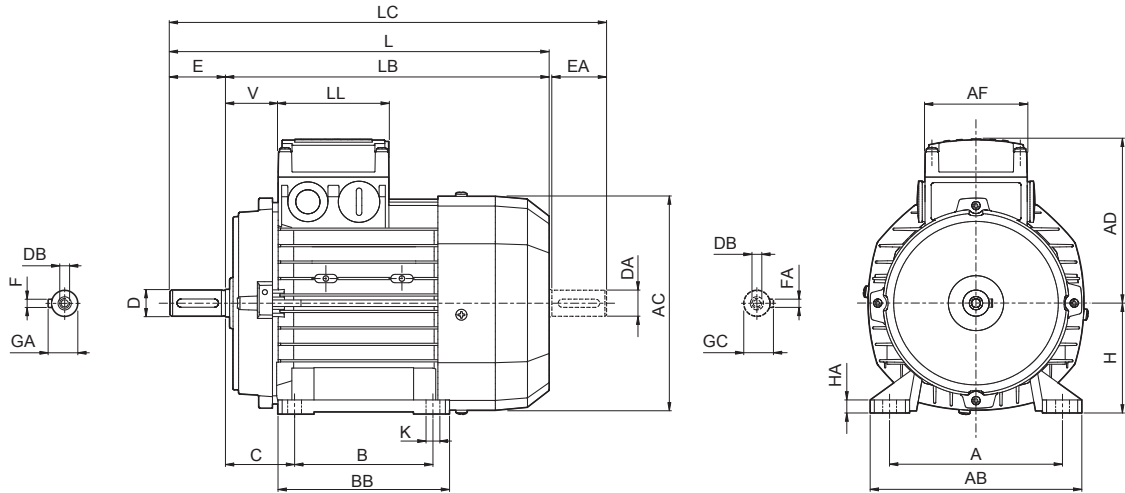

BN

	Shaft					Housing						Motor										
	D DA	E EA	DB	GA GC	F FA	B	A	HA	BB	AB	K	C	H	AC	L	LB	LC	AD	AF	LL	V	
BN 63	11	23	M4	12.5	4	80	100	8	96	120	7	40	63	121	207	184	232	95	74	80	30	
BN 71	14	30	M5	16	5	90	112	8	112	135		45	71	138	249	219	281	108				37
BN 80	19	40	M6	21.5	6	100	125	8	124	153		50	80	156	273	233	315	119				38
BN 90 S	24	50	M8	27	8	125	140	8	155	174	10	56	90	176	326	276	378	133	98	98	44	
BN 90 L																						
BN 100	28	60	M10	31	8	140	160	10	175	192	12	63	100	195	366	306	429	142	118	118	50	
BN 112							190															224
BN 132 S	38	80	M12	41	10	178	216	12	218	254	12	89	132	260	493	413	576	193	118	118	58	
BN 132 M																						
BN 160 M	42 38 ⁽¹⁾	110 80 ⁽¹⁾	M16 M12 ⁽¹⁾	45 41 ⁽¹⁾	12 10 ⁽¹⁾	210 254	254	25	264 304	319	14.5	108	160	310	596	486	680	245	187	187	51	
BN 160 L							254								304	319	14.5					108
BN 180 L	48 42 ⁽¹⁾	110 110 ⁽¹⁾	M16 M16 ⁽¹⁾	51.5 45 ⁽¹⁾	14 12 ⁽¹⁾	279	279	26	329	359	14	121	180	348	708	598	823	261	187	187	52	
BN 200 L							305								318	355	398					18

NOTE:
1) These values refer to the rear shaft end.

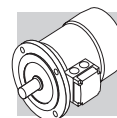

BN - IM B5

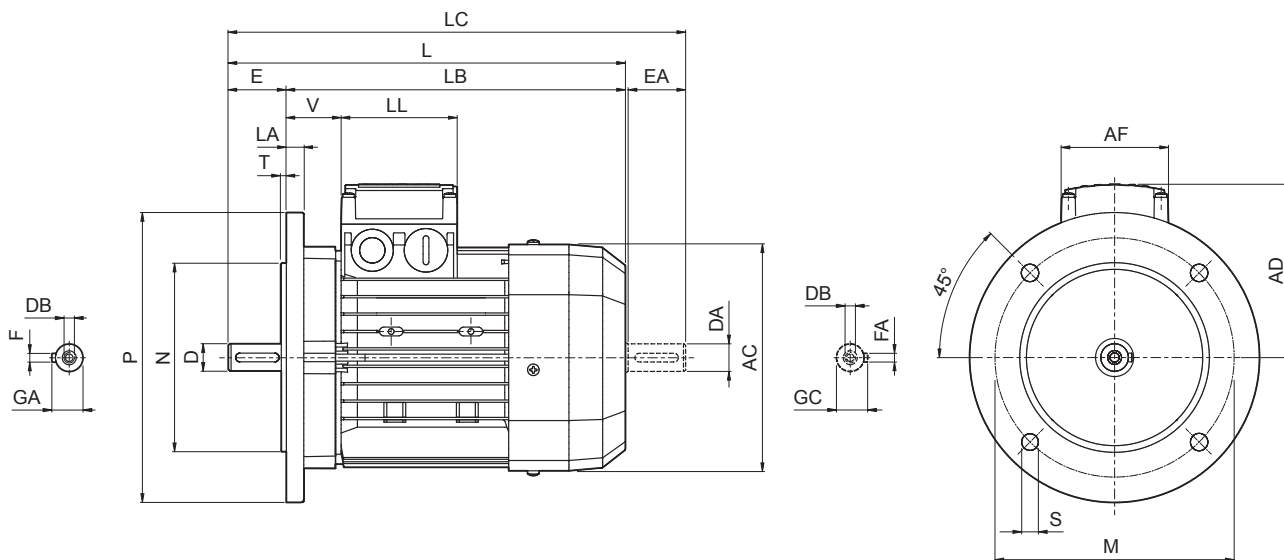

BN

	Shaft					Flange					Motor									
	D DA	E EA	DB	GA GC	F FA	M	N	P	S	T	LA	AC	L	LB	LC	AD	AF	LL	V	
BN 56	9	20	M3	10.2	3	100	80	120	7	3	8	110	185	165	207	91	74	80	34	
BN 63	11	23	M4	12.5	4	115	95	140	9.5		10	121	207	184	232				95	26
BN 71	14	30	M5	16	5	130	110	160			10	138	249	219	281				108	37
BN 80	19	40	M6	21.5	6	165	130	200	11.5	3.5	11.5	156	274	234	315	119	98	98	38	
BN 90	24	50	M8	27	8						176	326	276	378	133	44				
BN 100	28	60	M10	31	8	215	180	250	14	4	14	195	367	307	429	142	98	98	50	
BN 112											15	219	385	325	448	157			52	
BN 132	38	80	M12	41	10	265	230	300	18.5	5	20	258	493	413	576	193	118	118	58	
BN 160 MR	42 38 ⁽¹⁾	110 80 ⁽¹⁾	M16 M12 ⁽¹⁾	45 41 ⁽¹⁾	12 10 ⁽¹⁾	300	250	350			15		310	596	486				680	245
BN 160 M									18	348	708	598	823	261	51					
BN 160 L															15	310	640	530	724	187
BN 180 M	48 38 ⁽¹⁾	110 110 ⁽¹⁾	M16 M16 ⁽¹⁾	51.5 41 ⁽¹⁾	14 10 ⁽¹⁾	350	300	400	18	348	722	612	837	261	187	187	52			
BN 180 L	48 42 ⁽¹⁾			51.5 45 ⁽¹⁾	14 12 ⁽¹⁾													52		
BN 200 L	55 42 ⁽¹⁾			M20 M16 ⁽¹⁾	59 45 ⁽¹⁾													16 12 ⁽¹⁾	66	

NOTE:
1) These values refer to the rear shaft end.

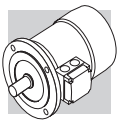

BN - IM B14

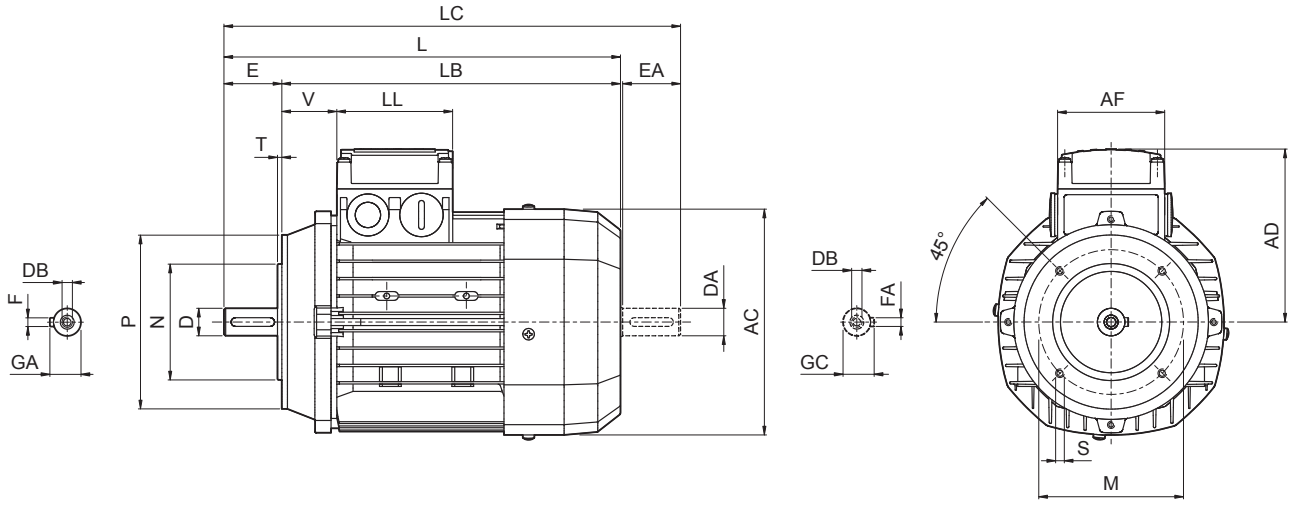

BN

	Shaft					Flange					Motor							
	D DA	E EA	DB	GA GC	F FA	M	N	P	S	T	AC	L	LB	LC	AD	AF	LL	V
BN 56	9	20	M3	10.2	3	65	50	80	M5	2.5	110	185	165	207	91	74	80	34
BN 63	11	23	M4	12.5	4	75	60	90			121	207	184	232	95			26
BN 71	14	30	M5	16	5	85	70	105	M6		138	249	219	281	108			37
BN 80	19	40	M6	21.5	6	100	80	120		3	156	274	234	315	119	38		
BN 90	24	50	M8	27	8	115	95	140	M8		3.5	176	326	276	378	133	98	98
BN 100	28	60	M10	31		130	110	160		195		367	307	429	142	50		
BN 112					219	385	325	448		157	52							
BN 132	38	80	M12	41	10	165	130	200	M10	4	258	493	413	576	193	118	118	58

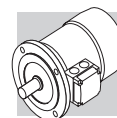

BN_FD ; IM B3

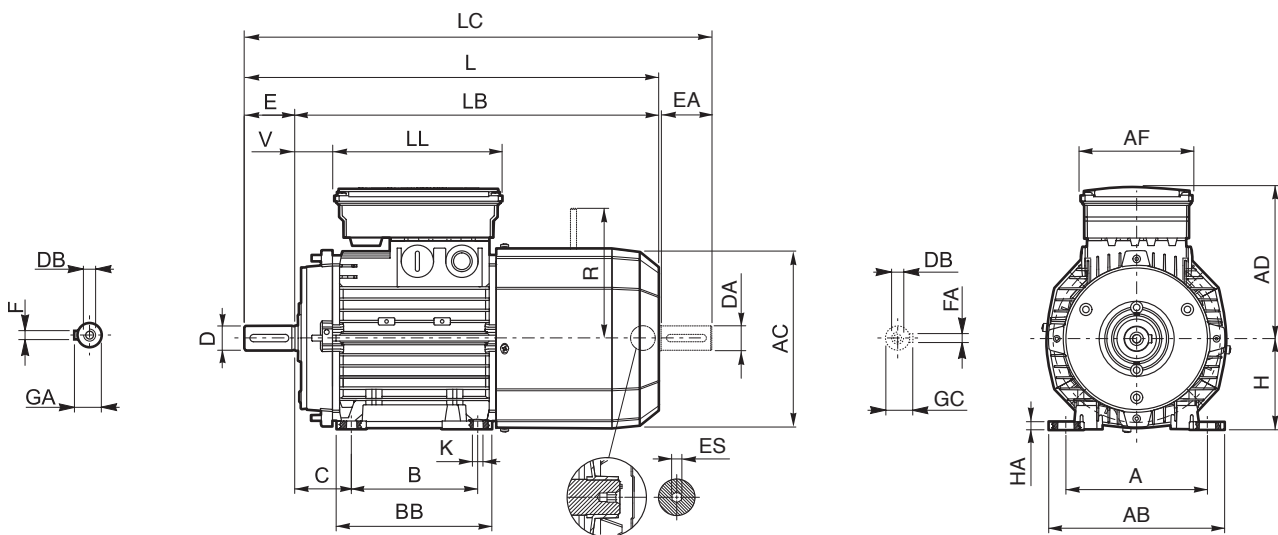

BN

	Shaft					Housing							Motor										
	D DA	E EA	DB	GA GC	F FA	B	A	HA	BB	AB	K	C	H	AC	L	LB	LC	AD	AF	LL	V	R	S
BN 63	11	23	M4	12.5	4	80	100	7	96	120	7	40	63	121	272	249	297	122	98	133	14	96	5
BN 71	14	30	M5	16	5	90	112		112	135		45	71	138	310	280	342	135			25	103	
BN 80	19	40	M6	21.5	6	100	125		8	124		153	50	80	156	346	306	388			146	41	
BN 90 S	24	50	M8	27	8	140	140	10	155	174	10	56	90	176	409	359	461	149	110	165	15	160	6
BN 90 L						125			192	63		100	195	458	398	521	158	39			62		
BN 100	28	60	M10	31	8	140	190	10	175	224	12	70	112	219	484	424	547	173	140	188	73	199	6
BN 112						178	218	254	89	132		260	603	523	686	210	46	204 ⁽²⁾					
BN 132 S	38	80	M12	41	10	210	254	25	264	319	14.5	108	160	310	736	626	820	245	187	187	51	266	—
BN 132 M						178			218						254	89	132						
BN 160 M	42	110	M16	45	12	210	254	25	264	319	14.5	108	160	310	736	626	820	245	187	187	51	266	—
BN 160 L	38 ⁽¹⁾					80 ⁽¹⁾			M12 ⁽¹⁾						41 ⁽¹⁾	10 ⁽¹⁾	254						
BN 180 L	48	110	M16	51.5	14	279	279	26	329	359	14	121	180	348	866	756	981	261	187	187	52	305	—
BN 200 L	42 ⁽¹⁾					110 ⁽¹⁾			M20						59	16	305						

NOTE:

- 1) These values refer to the rear shaft end.
- 2) For FD07 brake value R=226.

ES hexagon is not supplied with PS option.

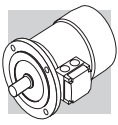

BN_FD ; IM B5

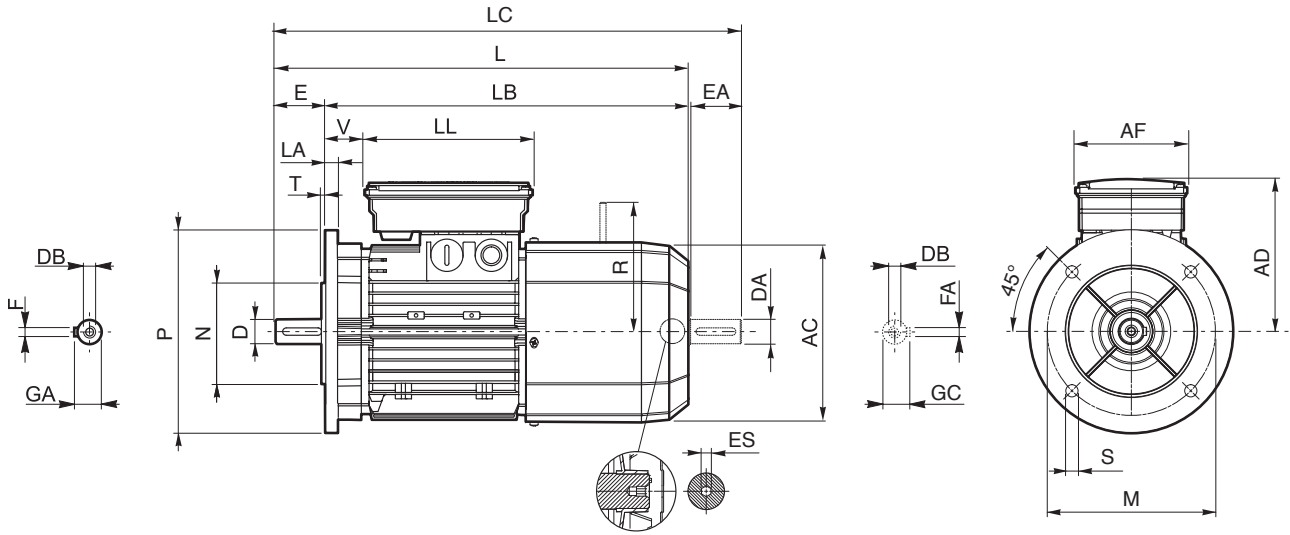

BN

	Shaft					Flange					Motor										
	D DA	E EA	DB	GA GC	F FA	M	N	P	S	T	LA	AC	L	LB	LC	AD	AF	LL	V	R	ES
BN 63	11	23	M4	12.5	4	115	95	140	9.5	3	10	121	272	249	297	122	98	133	14	96	5
BN 71	14	30	M5	16	5	130	110	160	9.5	3.5		138	310	280	342	135			25	103	
BN 80	19	40	M6	21.5	6	165	130	200	11.5		4	11.5	156	346	306	388	146	110	165	41	129
BN 90 S	24	50	M8	27	8					176			409	359	461	149	160				
BN 90 L						146	62														
BN 100	28	60	M10	31	14	215	180	250	14	4	14	195	458	398	521	158	165	73	199	204 ⁽²⁾	
BN 112												15	219	484	424	547			173		165
BN 132	38	80	M12	41	10	265	230	300	5	5	20	258	603	523	686	210	140	188	46	226	
BN 160 MR	42	110	M16	45	12	300	250	350				18.5	5	15	672				562	755	245
BN 160 M	38 ⁽¹⁾								41 ⁽¹⁾	10 ⁽¹⁾	187				187						
BN 160 L	42	80 ⁽¹⁾	M12 ⁽¹⁾	51.5	14	310	780	670	864	187	187	261	866	756	981	261	187	187	52	305	
BN 180 M	48	38 ⁽¹⁾	M16																41 ⁽¹⁾		10 ⁽¹⁾
BN 180 L	48	42 ⁽¹⁾	M16 ⁽¹⁾	45 ⁽¹⁾	12 ⁽¹⁾	350	300	400	18.5	5	18	348	866	756	981	261	187	187	64	305	
BN 200 L	55	42 ⁽¹⁾	M20	59	16														12 ⁽¹⁾		

NOTE:

1) These values refer to the rear shaft end.

2) For FD07 brake value R=226.

ES hexagon is not supplied with PS option.

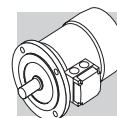

BN_FD ; IM B14

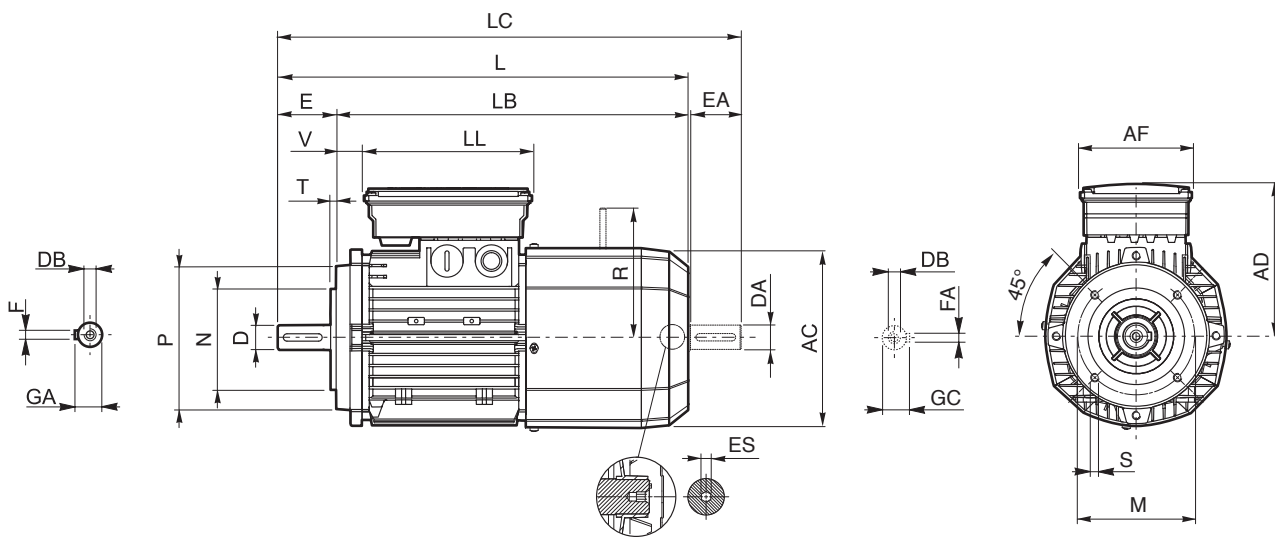

BN

	Shaft					Flange					Motor									
	D DA	E EA	DB	GA GC	F FA	M	N	P	S	T	AC	L	LB	LC	AD	AF	LL	V	R	ES
BN 63	11	23	M4	12.5	4	75	60	90	M5	2.5	121	272	249	297	122	98	133	14	96	5
BN 71	14	30	M5	16	5	85	70	105	M6		138	310	280	342	135			25	103	
BN 80	19	40	M6	21.5	6	100	80	120	M6		156	346	306	388	146			41	129	
BN 90 S	24	50	M8	27	8	115	95	140	M8	3	176	409	359	461	149	110	165	39	129	6
BN 90 L															146				160	
BN 100	28	60	M10	31	8	130	110	160	M8	3.5	195	458	398	521	158	110	165	62	160	6
BN 112															173				73	
BN 132	38	80	M12	41	10	165	130	200	M10	4	258	603	523	686	210	140	188	46	204 ⁽¹⁾	

NOTE:

1) For FD07 brake value R=226.

ES hexagon is not supplied with PS option.

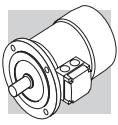

BN_FA - IM B3

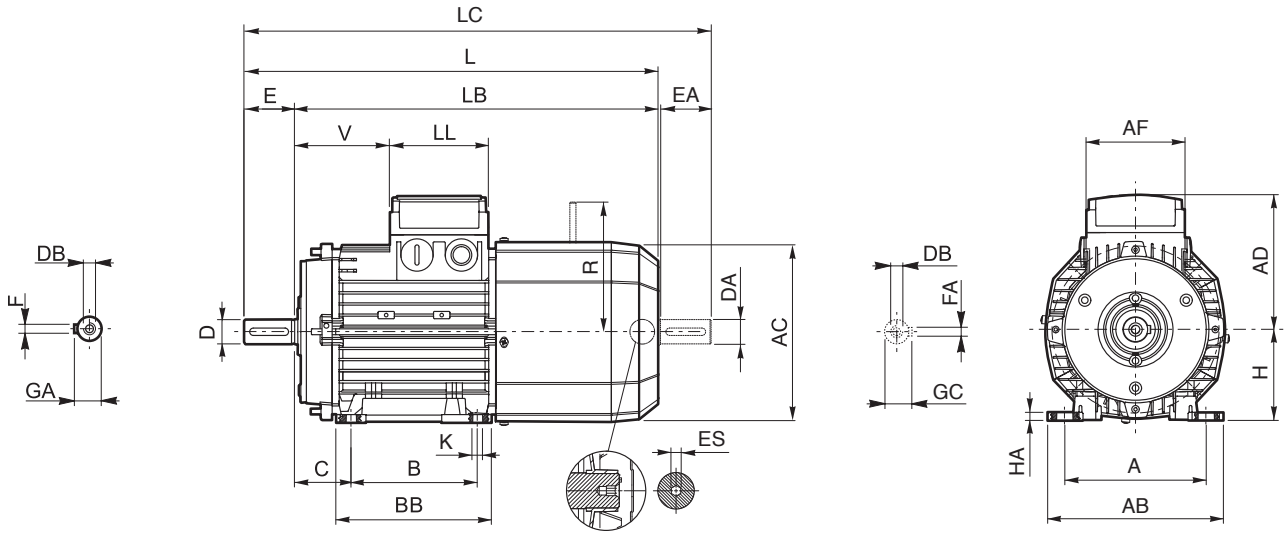

BN

	Shaft					Housing							Motor										
	D DA	E EA	DB	GA GC	F FA	B	A	HA	BB	AB	K	C	H	AC	L	LB	LC	AD	AF	LL	V	R	S
BN 63	11	23	M4	12.5	4	80	100	7	96	120	7	40	63	121	272	249	297	95	74	80	51	116	5
BN 71	14	30	M5	16	5	90	112		112	135		45	71	138	310	280	342	108			68	124	
BN 80	19	40	M6	21.5	6	100	125		8	124		153	50	80	156	346	306	388			119	83	
BN 90 S	24	50	M8	27	8	140	140	10	155	174	10	56	90	176	409	359	461	133	98	98	71	160	6
BN 90 L						125			192	63		100	195	458	398	521	142	119			198		
BN 100	28	60	M10	31	10	140	190	10	175	224	70	112	219	484	424	547	157	128	198				
BN 112						140	190	70	112	219	484	424	547	157	128	198							
BN 132 S	38	80	M12	41	10	216	12	218	254	12	89	132	260	603	523	686	210	140	188	46	200 ⁽²⁾	—	
BN 132 M						178	254	25	319		14.5	108	160	310	736	626	820	245	187	187	51		247
BN 160 M	42	110	M16	45	12	210	254	25	264	319	14.5	108	160	310	736	626	820	245	187	187	51	247	—
BN 160 L	38 ⁽¹⁾	80 ⁽¹⁾	M12 ⁽¹⁾	41 ⁽¹⁾	10 ⁽¹⁾	254			304						780	670	864						

NOTE:

- 1) These values refer to the rear shaft end.
- 2) For FA07 brake value R=217.

Dimensions AD, AF, LL and V, relevant to terminal box of motors BN...FA featuring the separate brake supply (option SA), are coincident with corresponding dimensions of same-size BN...FD motors

ES hexagon is not supplied with PS option.

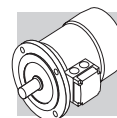

BN_FA - IM B5

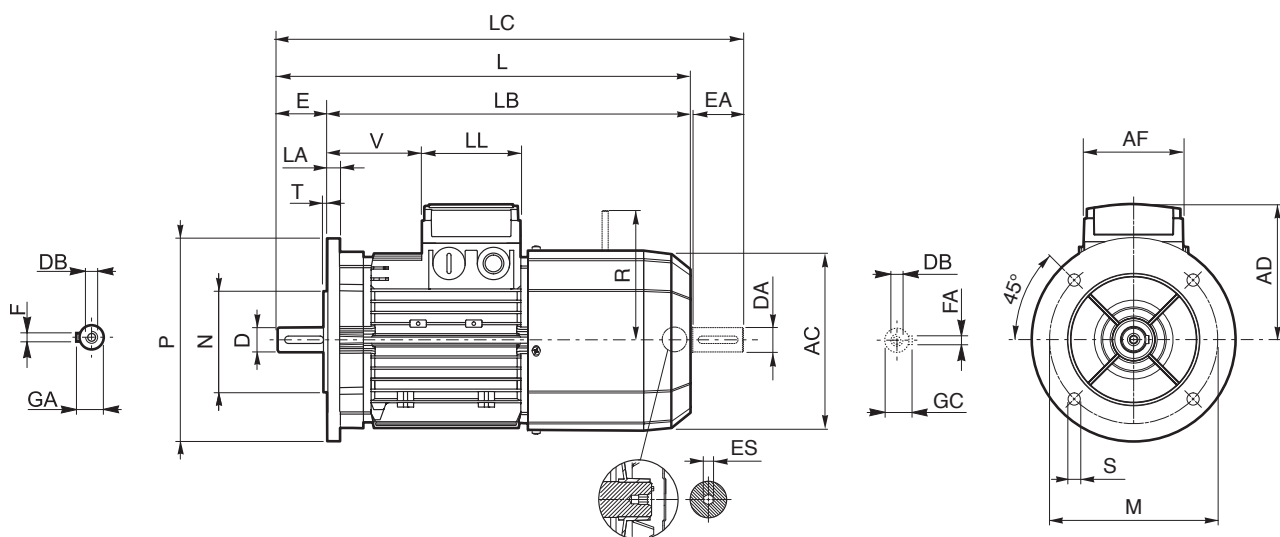

BN

	Shaft					Flange						Motor									
	D DA	E EA	DB	GA GC	F FA	M	N	P	S	T	LA	AC	L	LB	LC	AD	AF	LL	V	R	ES
BN 63	11	23	M4	12.5	4	115	95	140	9.5	3	10	121	272	249	297	95	74	80	26	116	5
BN 71	14	30	M5	16	5	130	110	160				138	310	280	342	108			68	124	
BN 80	19	40	M6	21.5	6	165	130	200	11.5	3.5	11.5	156	346	306	388	119			83	134	
BN 90	24	50	M8	27	8	215	180	250	14	4	14	176	409	359	461	133	98	98	95	160	6
BN 100	28	60	M10	31								219	484	424	547	157			128	198	
BN 112					15	219	484	424	547	157	128	198									
BN 132	38	80	M12	41	10	265	230	300	18.5	5	15	20	603	523	686	210	140	188	46	200 ⁽²⁾	—
BN 160 MR	42 38 ⁽¹⁾	110 80 ⁽¹⁾	M16 M12 ⁽¹⁾	45 41 ⁽¹⁾	12 10 ⁽¹⁾	300	250	350				18.5	5	15	258	672	562	755	193	118	
BN 160 M									736	626	820				245	187	187	51	247		
BN 160 L									310	780	670				864	245	187	187	51	247	
BN 180 M									51.5 41 ⁽¹⁾	14 10 ⁽¹⁾	780				670	864	245	187	187	51	247

NOTE:

- 1) These values refer to the rear shaft end.
- 2) For FA07 brake value R=217.

Dimensions AD, AF, LL and V, relevant to terminal box of motors BN...FA featuring the separate brake supply (option SA), are coincident with corresponding dimensions of same-size BN...FD motors

ES hexagon is not supplied with PS option.

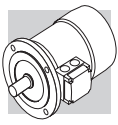

BN_FA - IM B14

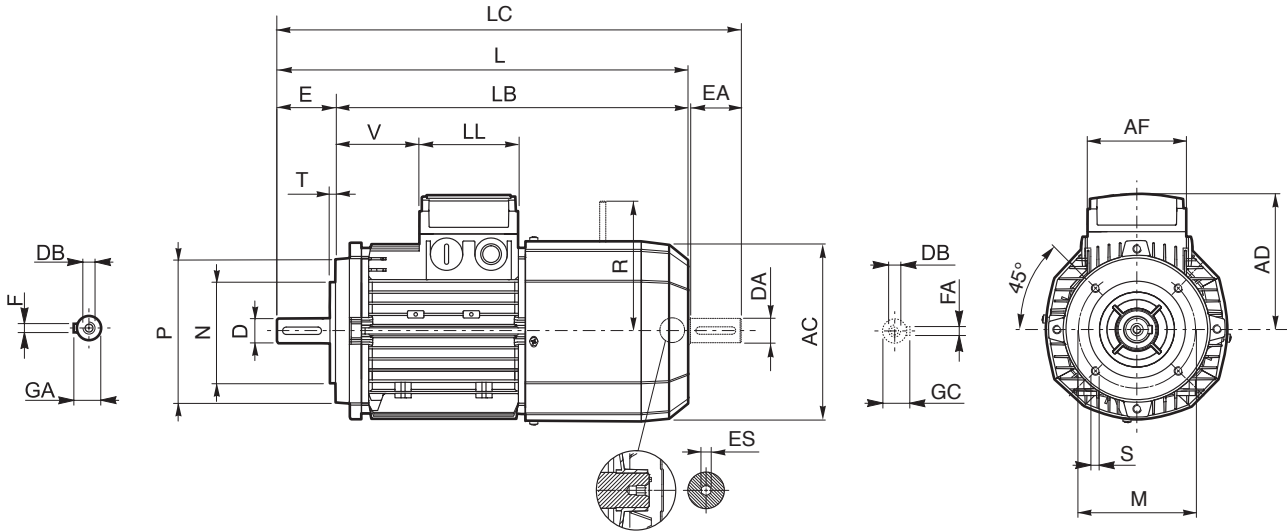

BN

	Shaft					Flange					Motor									
	D DA	E EA	DB	GA GC	F FA	M	N	P	S	T	AC	L	LB	LC	AD	AF	LL	V	R	ES
BN 63	11	23	M4	12.5	4	75	60	90	M5	2.5	121	272	249	119	95	74	80	26	116	5
BN 71	14	30	M5	16	5	85	70	105	M6		138	310	280	342	108			68	124	
BN 80	19	40	M6	21.5	6	100	80	120	M8	3	156	346	306	388	119	83	134	160	6	
BN 90	24	50	M8	27	8	115	95	140		3	176	409	359	461	133	95	198			
BN 100	28	60	M10	31	8	130	110	160	M8	3.5	195	458	398	521	142	98	98	119	198	
BN 112											219	484	424	547	157	128				
BN 132	38	80	M12	41	10	165	130	200	M10	4	258	603	523	686	210	140	188	46	200 ⁽¹⁾	

NOTE:

1) For FA07 brake value R=217.

Dimensions AD, AF, LL and V, relevant to terminal box of motors BN...FA featuring the separate brake supply (option SA), are coincident with corresponding dimensions of same-size BN...FD motors

ES hexagon is not supplied with PS option.

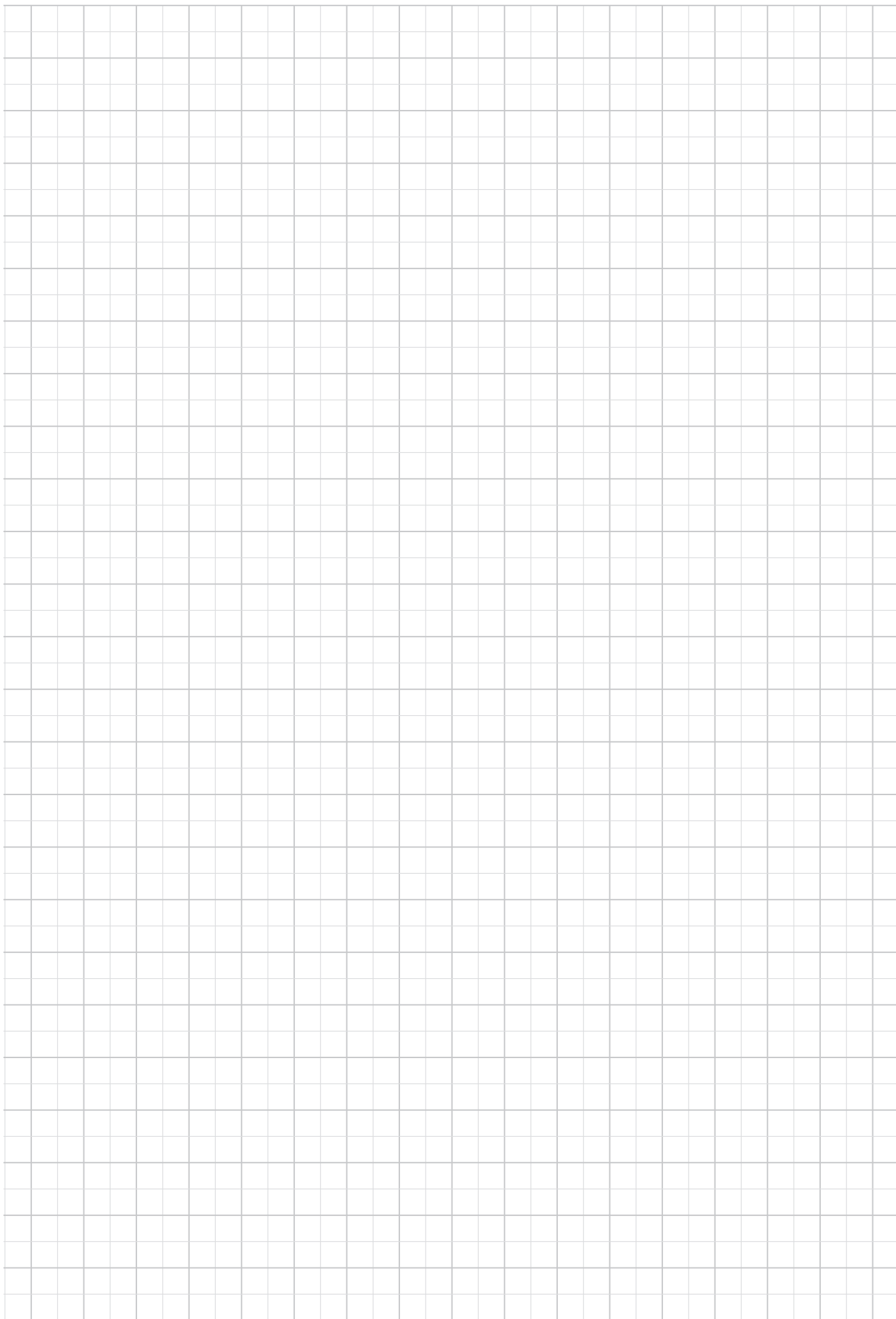
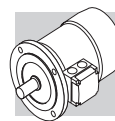

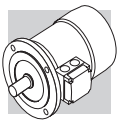

INDEX OF REVISIONS

BR_CAT_BNEX_STD_ENG_R04_0	
	Description
...	Added the availability of new BX 200LA ... BX 355MCK motors.

2019 01 15

This publication supersedes and replaces any previous edition and revision. We reserve the right to implement modifications without notice.

This catalogue cannot be reproduced, even partially, without prior consent.



We have a relentless commitment to excellence, innovation and sustainability. Our team creates, distributes and services world-class power transmission and drive solutions to keep the world in motion.

HEADQUARTERS

Bonfiglioli Riduttori S.p.A.
Via Giovanni XXIII, 7/A
40012 Lippo di Calderara di Reno
Bologna (Italy)
tel: +39 051 647 3111
fax: +39 051 647 3126
bonfiglioli@bonfiglioli.com
www.bonfiglioli.com

